



Beam test of prototype muon counters for SHiP experiment in CERN

V. Likhacheva on behalf of INR RAS team

February, 2016

Physical motivation

Three Generations
of Matter (Fermions) spin $\frac{1}{2}$

	I	II	III	Bosons (Forces) spin 1	
mass →	2.4 MeV	1.27 GeV	171.2 GeV	0	0
charge →	$\frac{2}{3}$	$\frac{2}{3}$	$\frac{2}{3}$	0	0
name →	u up	c charm	t top	g gluon	γ photon
	Left Right	Left Right	Left Right	0	0
	d down	s strange	b bottom	Z ⁰ weak force	H Higgs boson
Quarks	$-\frac{1}{3}$	$-\frac{1}{3}$	$-\frac{1}{3}$	91.2 GeV	>114 GeV
	Left Right	Left Right	Left Right	0	0
	ν_e N₁ electron neutrino sterile neutrino	ν_μ N₂ muon neutrino sterile neutrino	ν_τ N₃ tau neutrino sterile neutrino	W [±] weak force	spin 0
	0	0	0	80.4 GeV	
Leptons	-1	-1	-1	±1	
	Left Right	Left Right	Left Right		
	e electron	μ muon	τ tau		
	0.511 MeV	105.7 MeV	1.777 GeV		

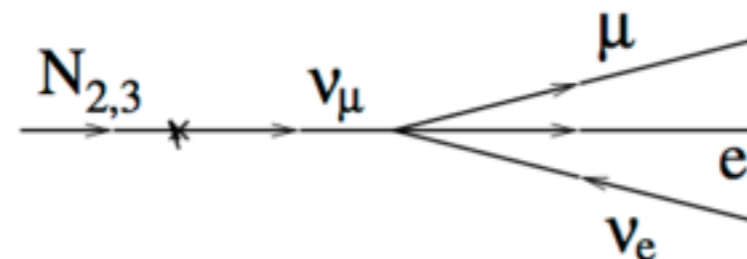
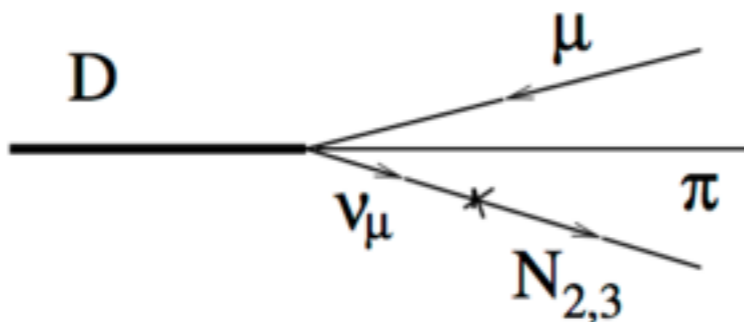
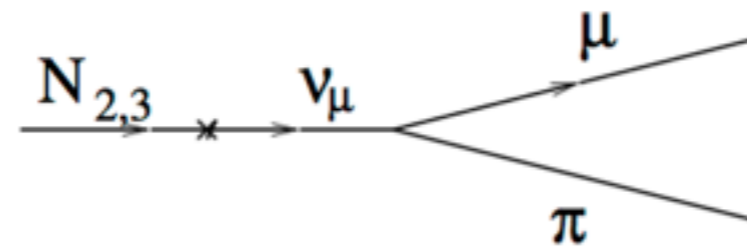
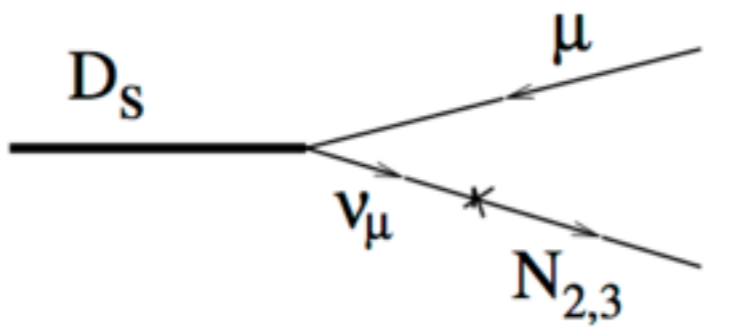

Proposal for SHiP experiment at SPS

A new general purpose fixed target facility is proposed at the CERN SPS accelerator to explore the domain of hidden particles and make measurements with tau neutrinos. The high intensity SPS 400 GeV beam allows probing a wide variety of models containing light long-lived exotic particles with masses below $10-90 \text{ GeV}/c^2$. The SHiP facility provides a unique combination of intensity and energy capable of producing the large yields required.

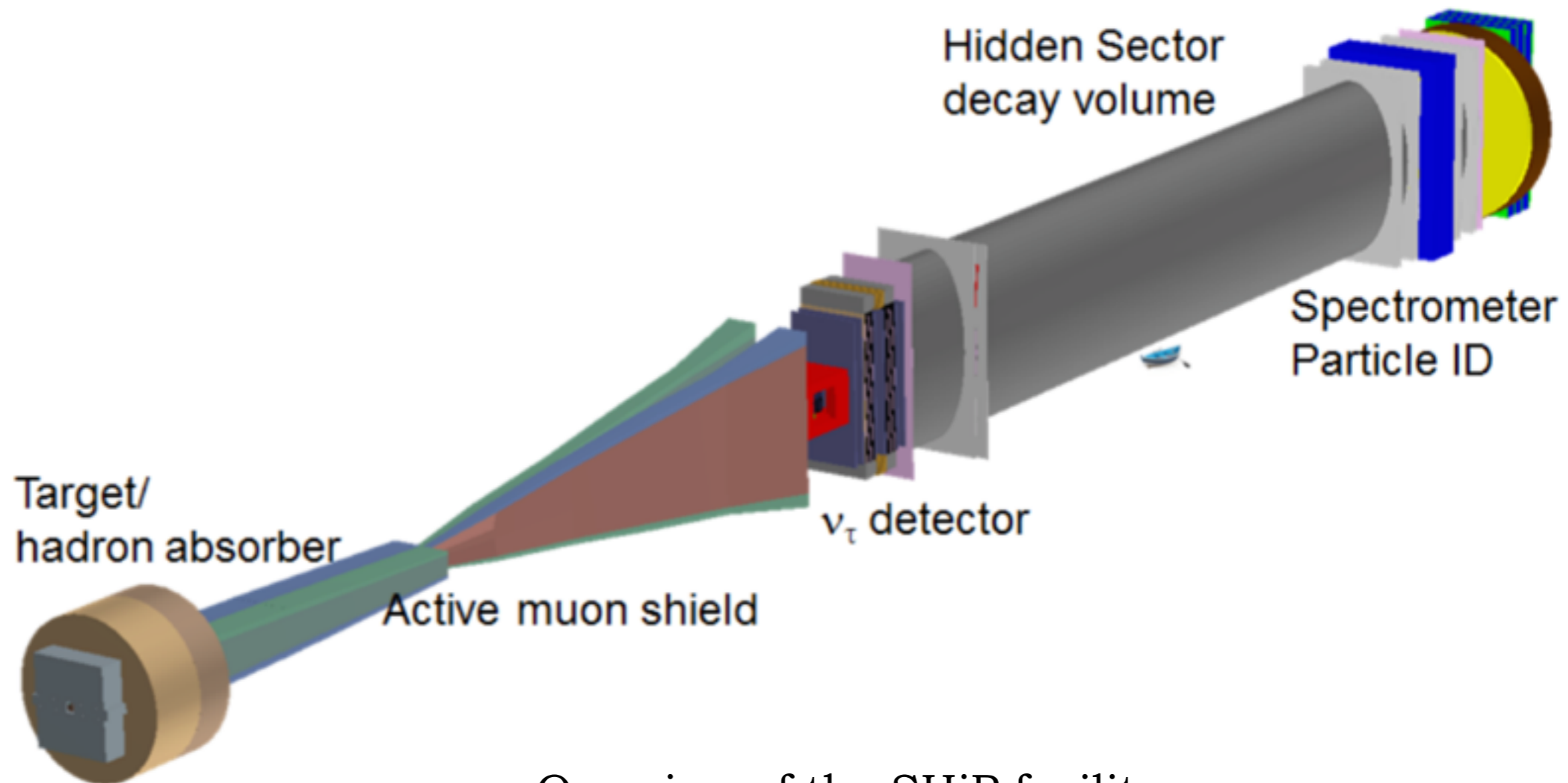

Overview of the SHiP facility.

Requires long decay volume, magnetic spectrometer, muon detector and electromagnetic calorimeter.

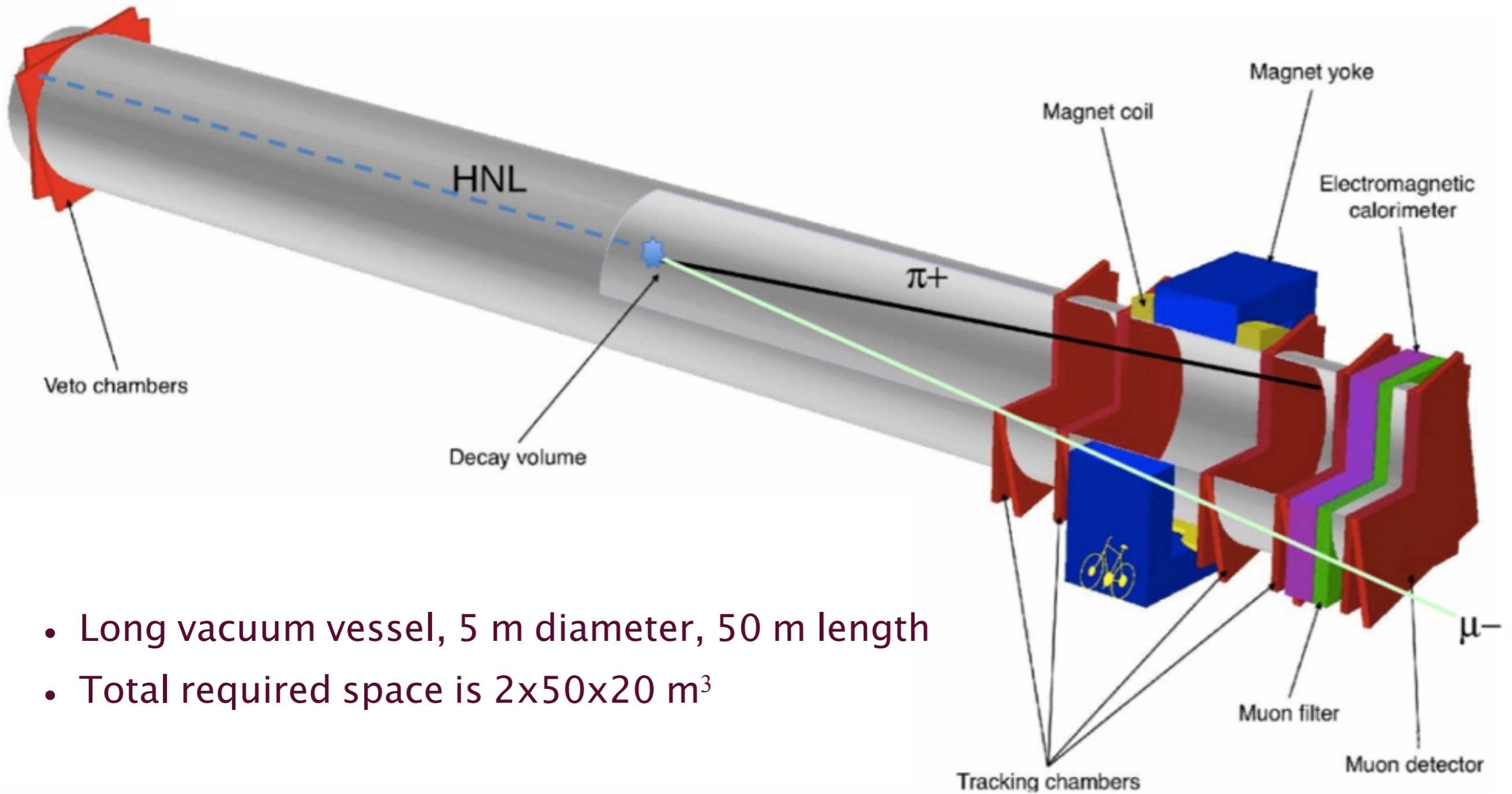

- Long vacuum vessel, 5 m diameter, 50 m length
- Total required space is $2 \times 50 \times 20 \text{ m}^3$

Requirements for the Muon System:

- 1) Positive identification of signals with muons in the final state with high efficiency;
- 2) Mild separation between muon and hadrons/electrons;
- 3) Help the timing detector in rejecting muon combinatorial background.

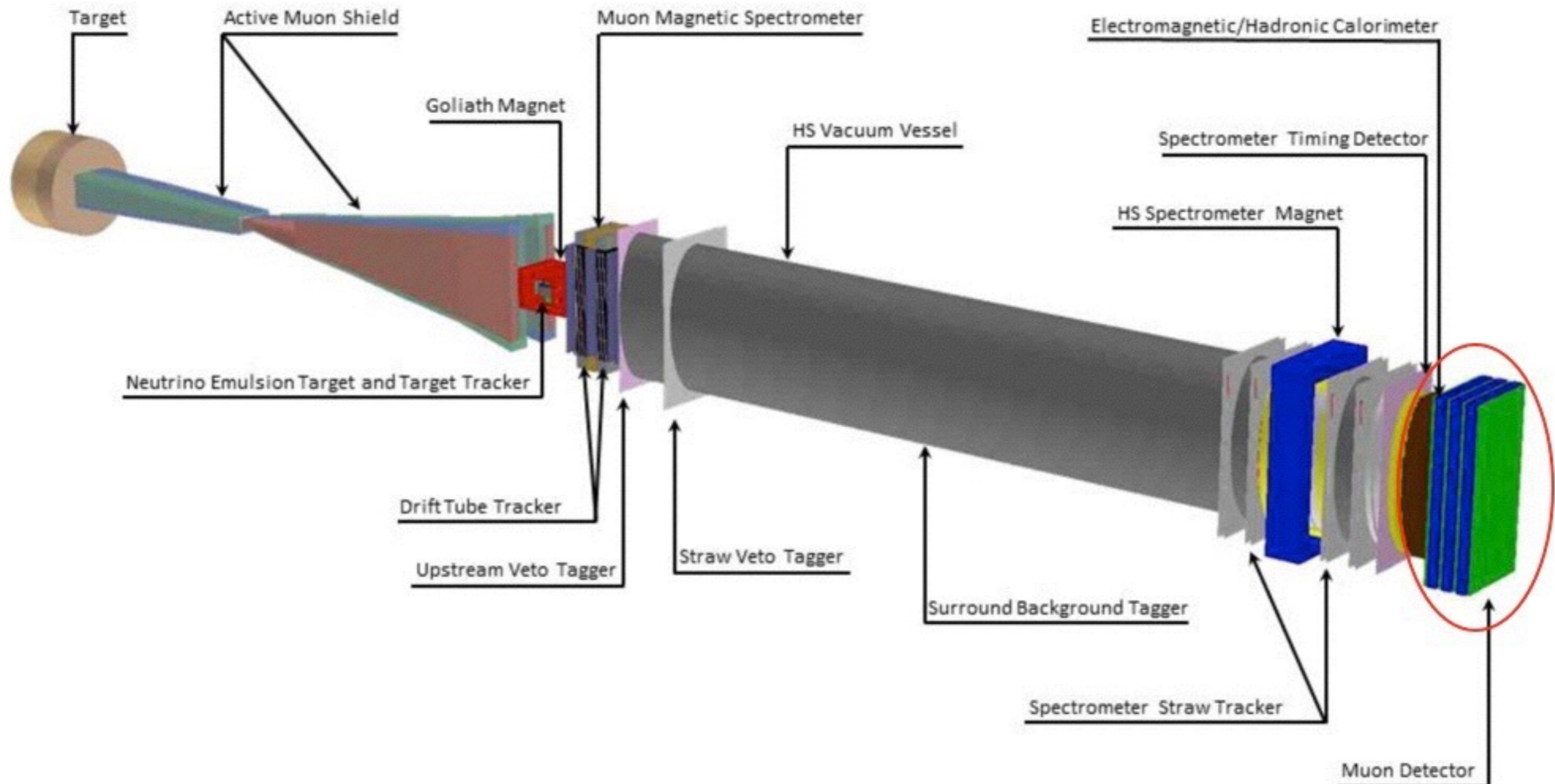

Muon detector:

based on scintillating bars, with WLS fibers and SiPM readout

Technical Proposal:

- 4 active stations;
- transverse dimensions: $1200 \times 600 \text{ cm}^2$ - x,y view
- 3380 bars, $5 \times 300 \times 2 \text{ cm}^3$ /each
- 7760 FEE channels
- 1000 tons for iron filters

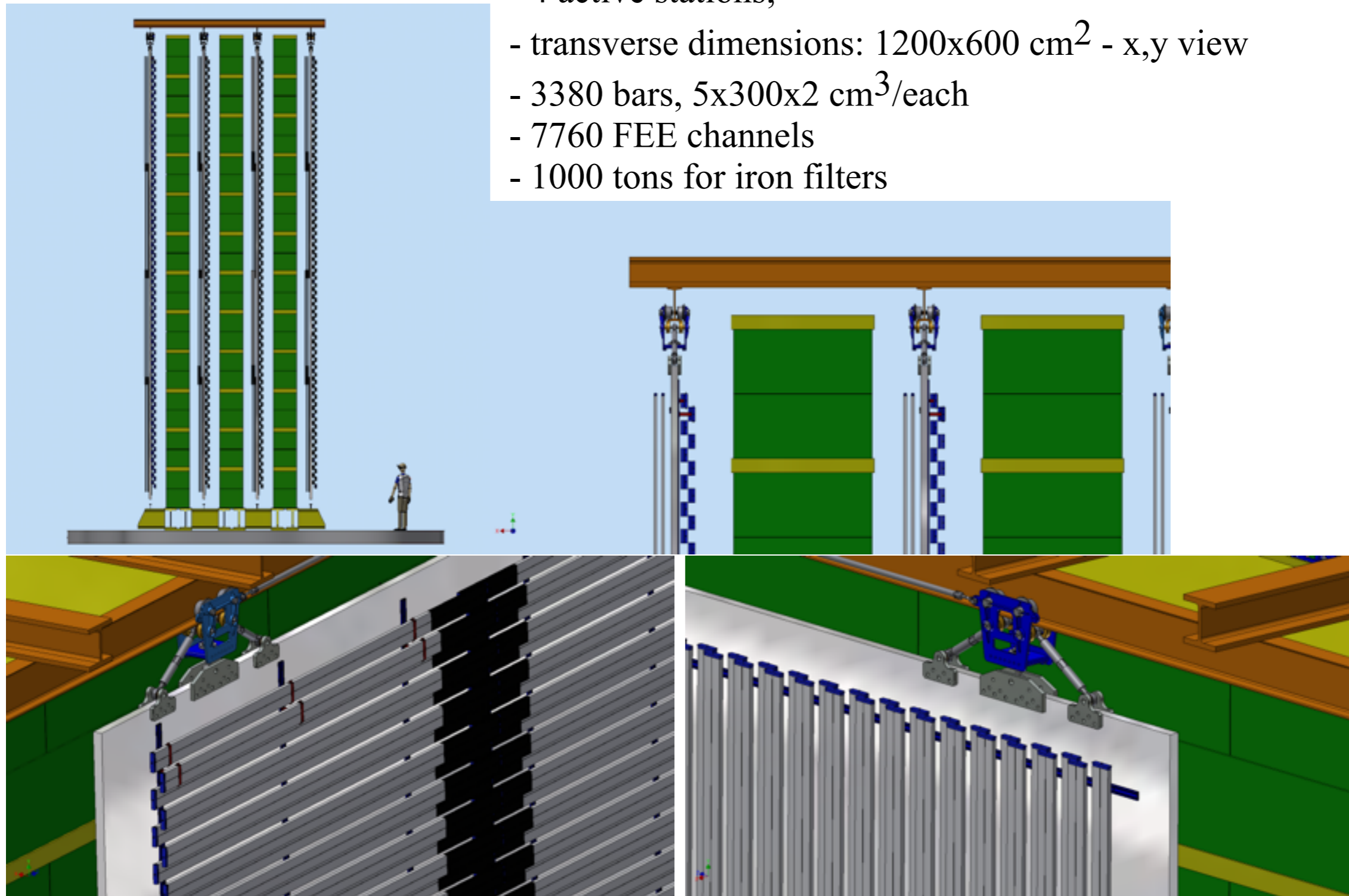

4 types of bars in the beam test

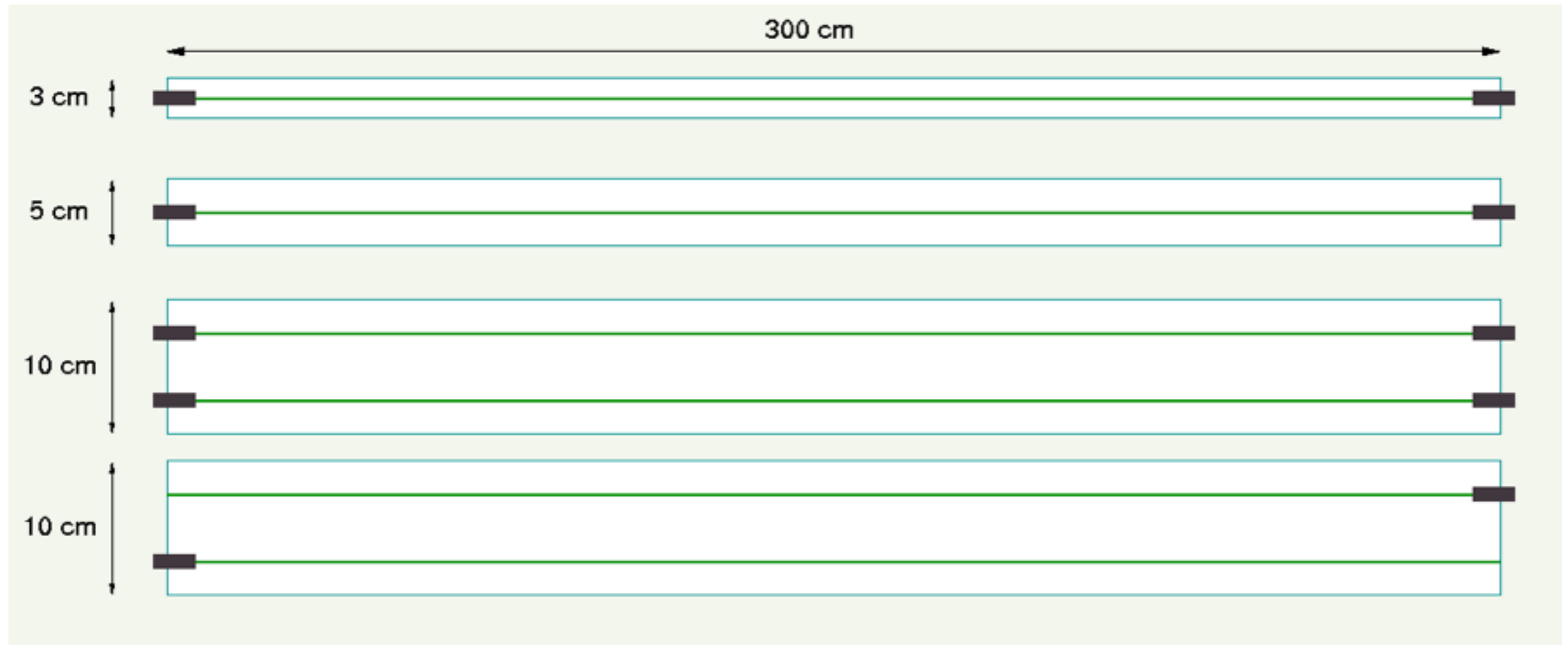

All bars are **7 mm thick** and **3 m long**. One of the 10 cm wide bars is made with the fiber single end readout. Two fibers in 10 cm bars are spaced at 5 cm.

The scintillators were manufactured at Uniplast Co. in Vladimir (Russia) by extrusion. The diffuse reflector is made by chemical etching of scintillator surface. The fibers and optical connectors were embedded in the bars at INR RAS, Moscow. Fibers are **Kuraray WLS Y11 multi-clad** fibers of 1 mm diameter. Glue is optical cement **EJ500**.

Plastic optical connectors were molded at Uniplast Co. to contain Hamamatsu MPPC SiPMs.

Optical couplers

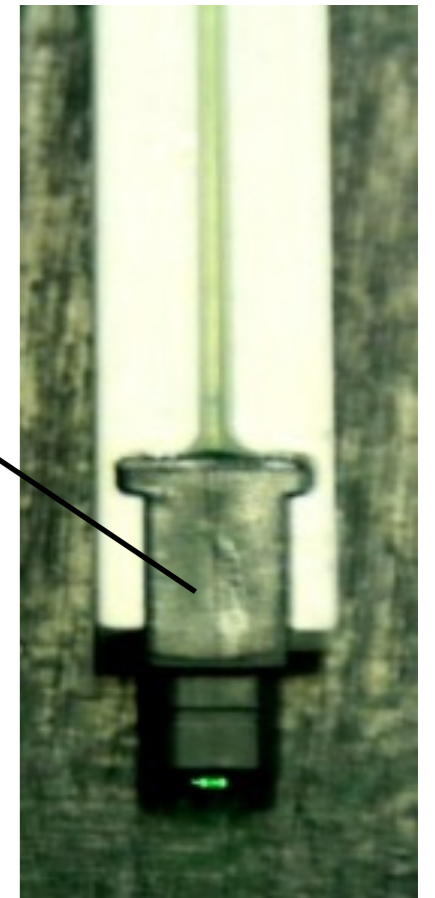
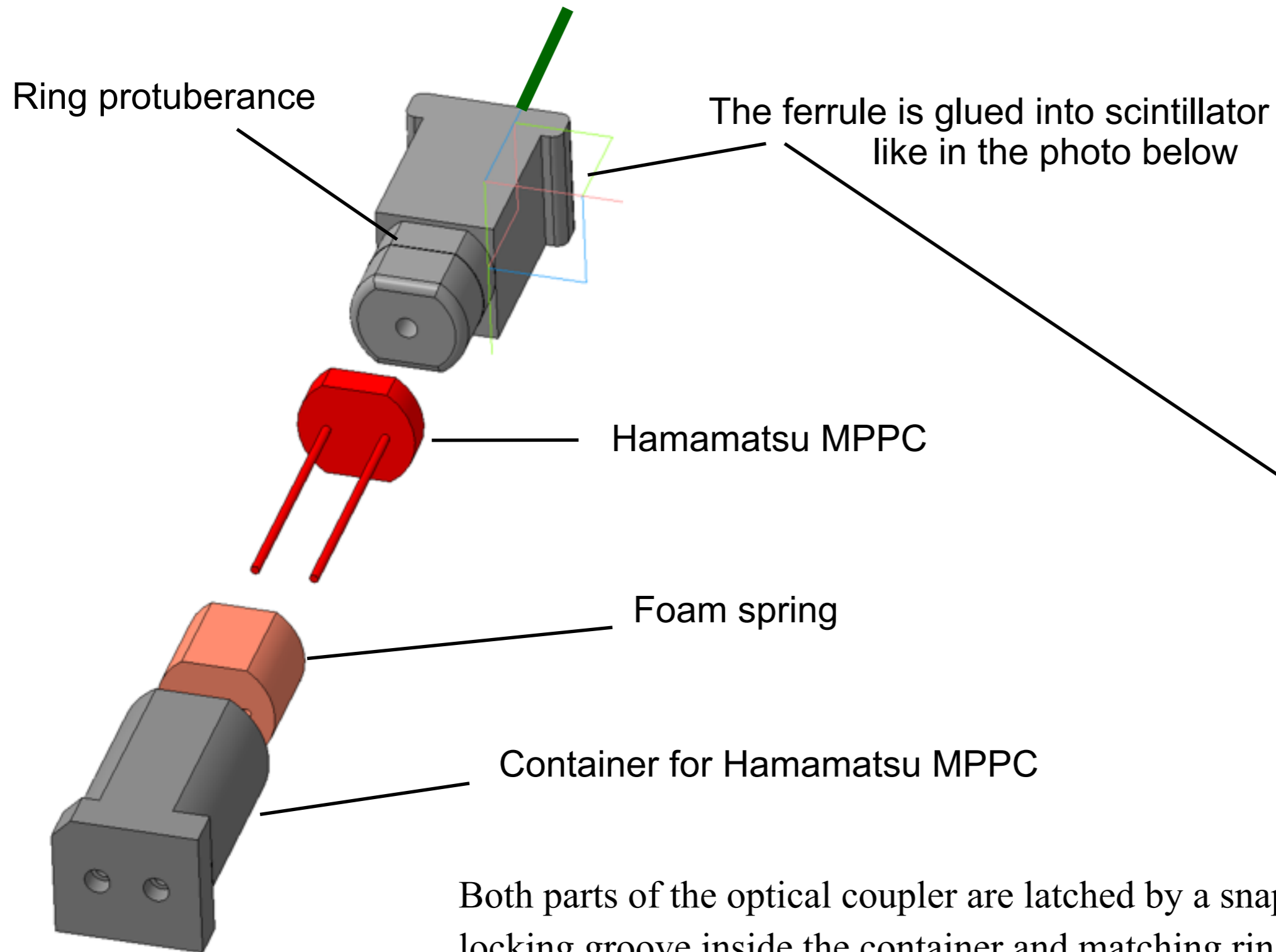

Both parts of the optical coupler are latched by a snap-like mechanism: locking groove inside the container and matching ring protuberance on the ferrule.

Front-end electronics and DAQ

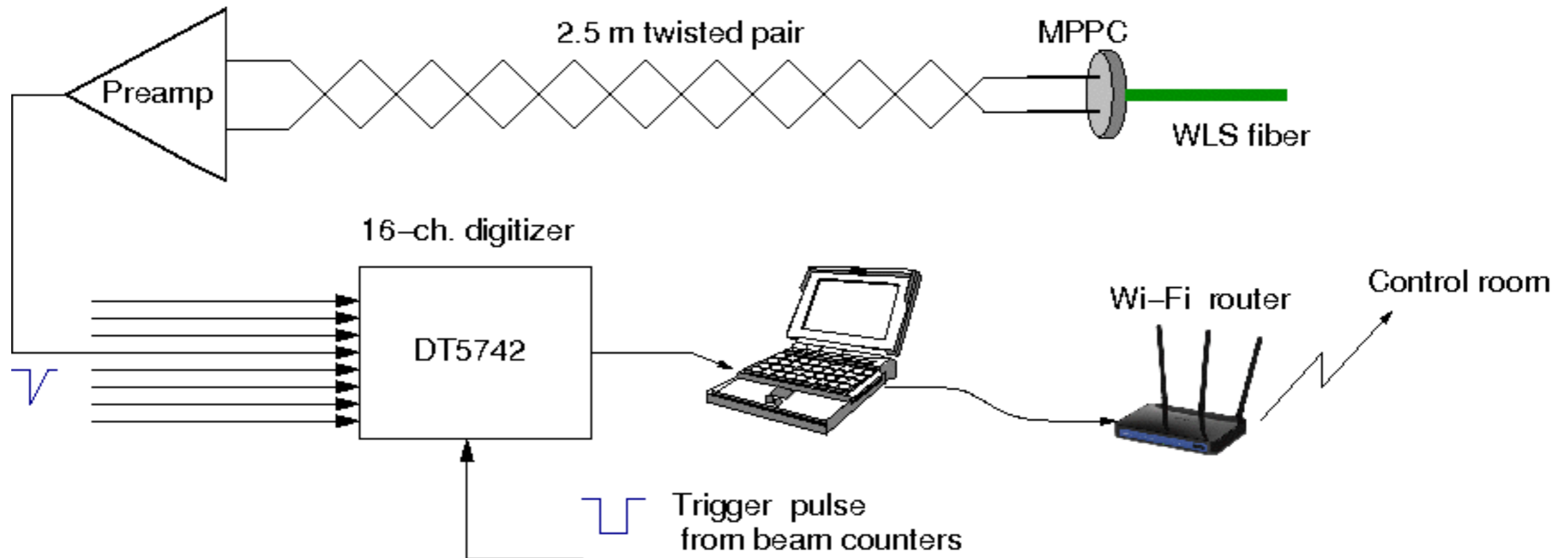

CAEN digitizer DT5742: 16 channels,
5 GHz sampling rate,
200 ns time window at 5 GHz,
12-bit resolution

Photosensors

Hamamatsu MPPC S13081-050CS

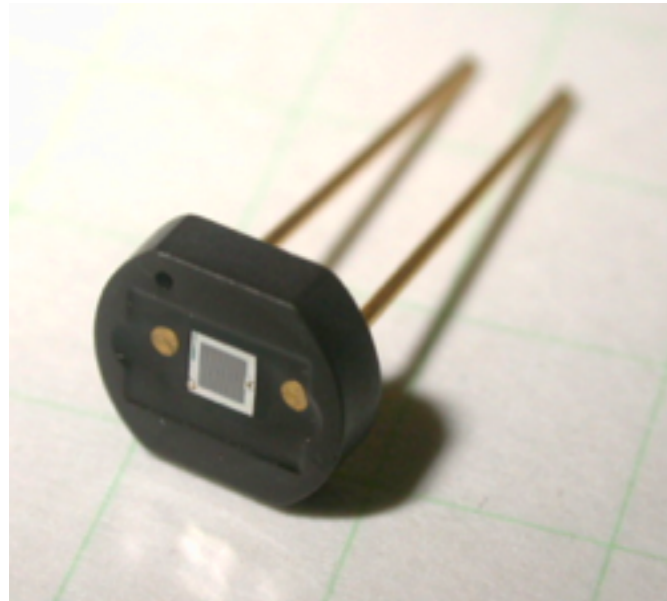

The advantage of this last MPPC generation is the reduced crosstalk and afterpulsing comparing with previous MPPC products.

HAMAMATSU SPECIFICATION:

Sensitive area size : **1.3x1.3 mm²**
Number of pixels : **667**
Pixel size : **50x50 μm²**

Gain : **1.5 x10⁶**
Operating voltage: **~ 54.6 V**
Peak spectral sensitivity: **450 nm**
Dark count : **90 kHz (typical)**
Crosstalk: **~ 1 %**
PDE at 450 nm: **35 %**

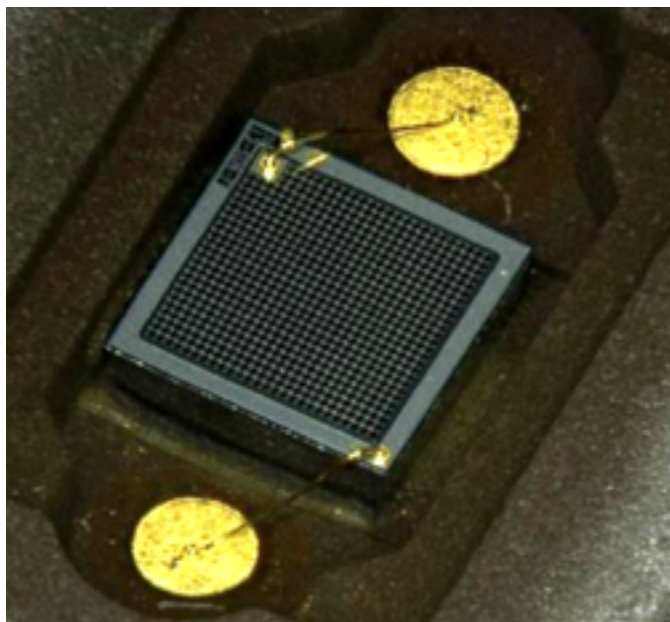

Test of extruded bar scintillators at PS T9 beam line in CERN

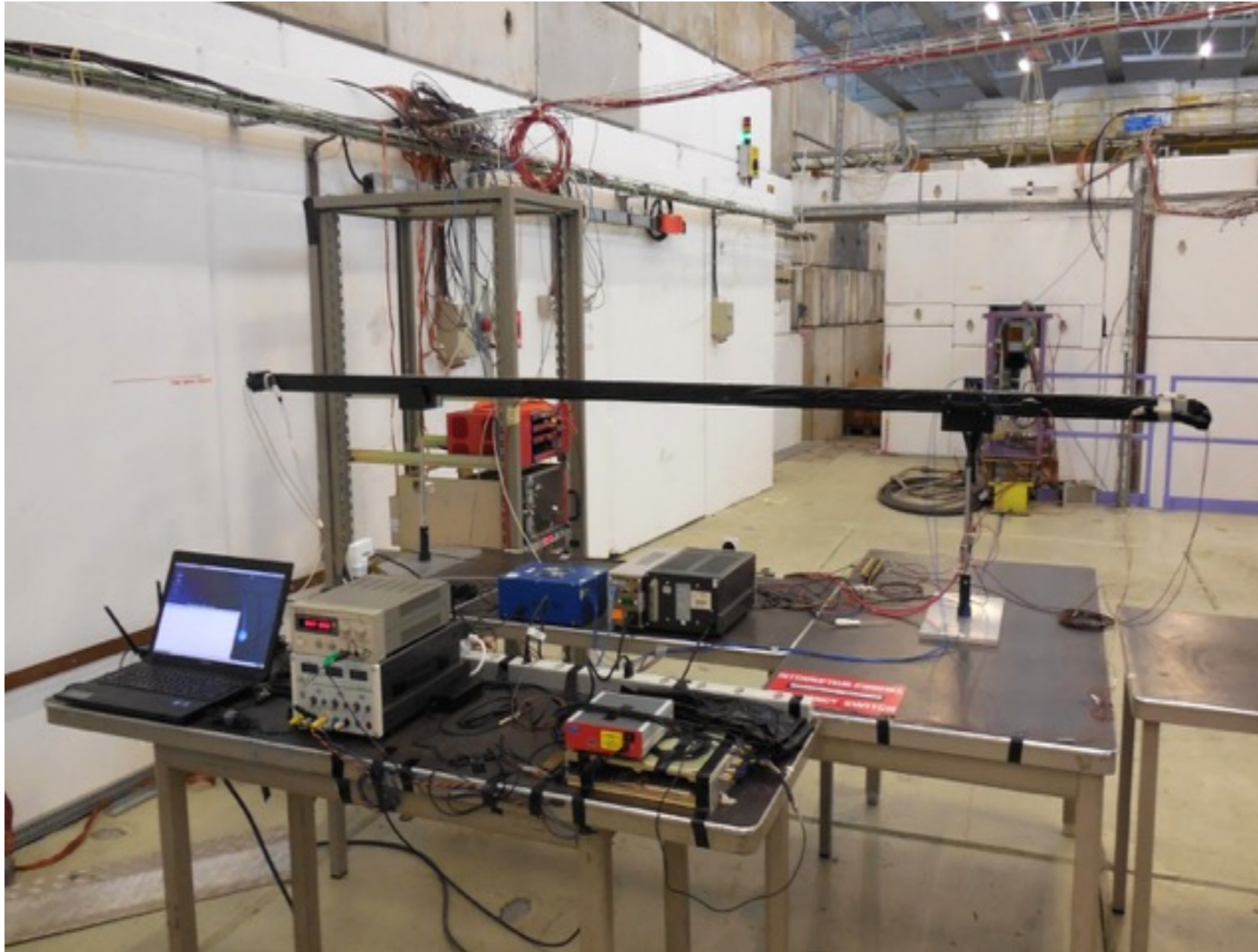

Beam: ρ , π **10 GeV/c**

Composition:

mainly π^-

Beam size:

Trigger counters
cut the beam spot
1(horiz.)x5(vert.) cm^2

Waveforms of signals after preamplifiers

Typical pulse shape of a signal after the preamp.

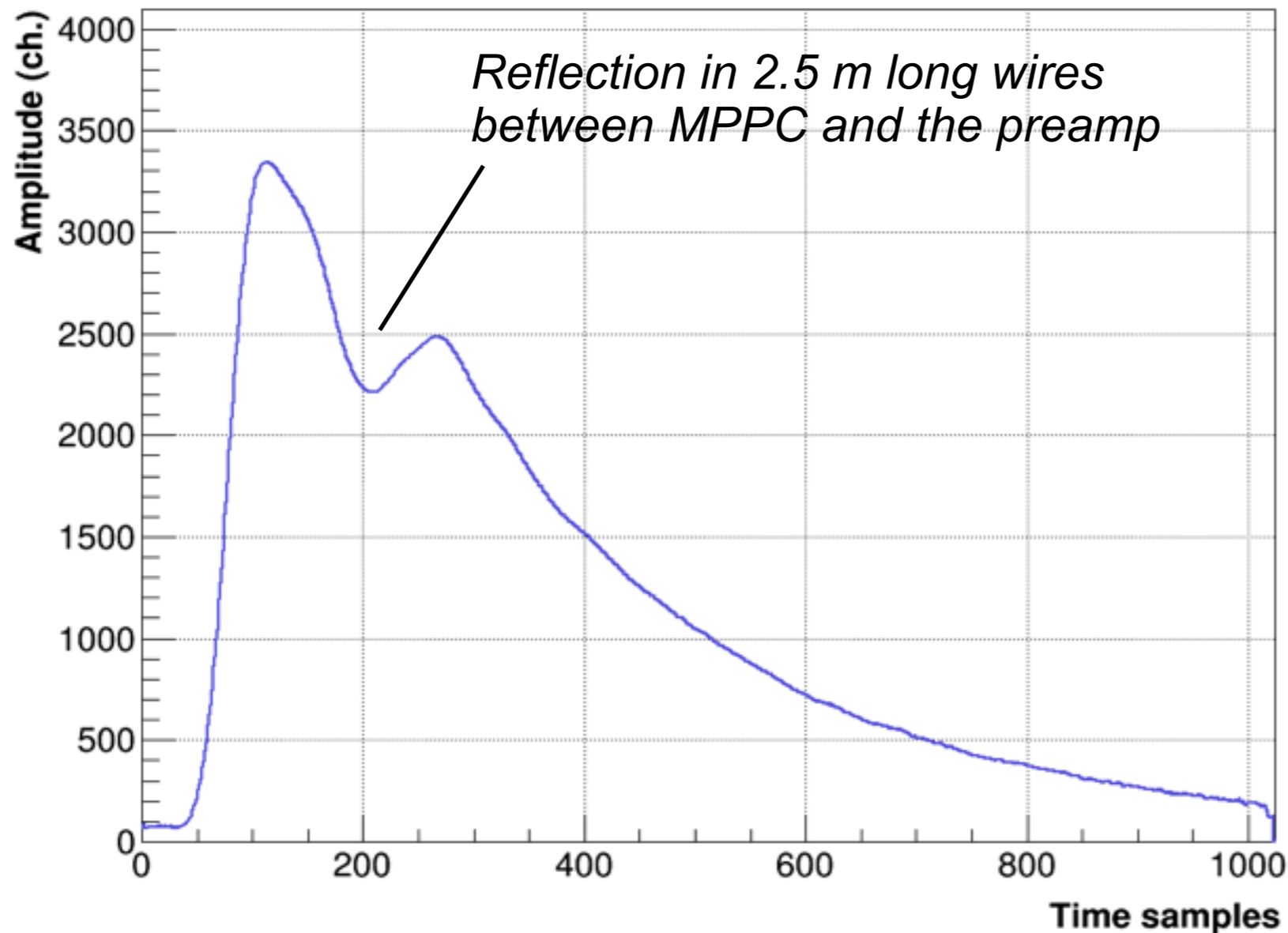

Digitizer time range:
1024 time stamps with
200 ps step between stamps.
The whole time window is
200 ns for 5 GHz sampling rate.

Pulse charge is calculated
by integration of amplitudes
over 200 ns window.

← 200 ns →

Light yield over length in 3- and 5-cm bars

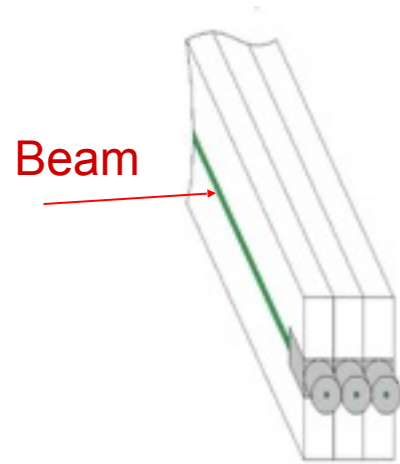

3 bars were irradiated in the beam. The plot shows **the average result** for all 3 tested bars. Red points are the sum from both ends.

No correction was made for temperature fluctuations (± 2 C).

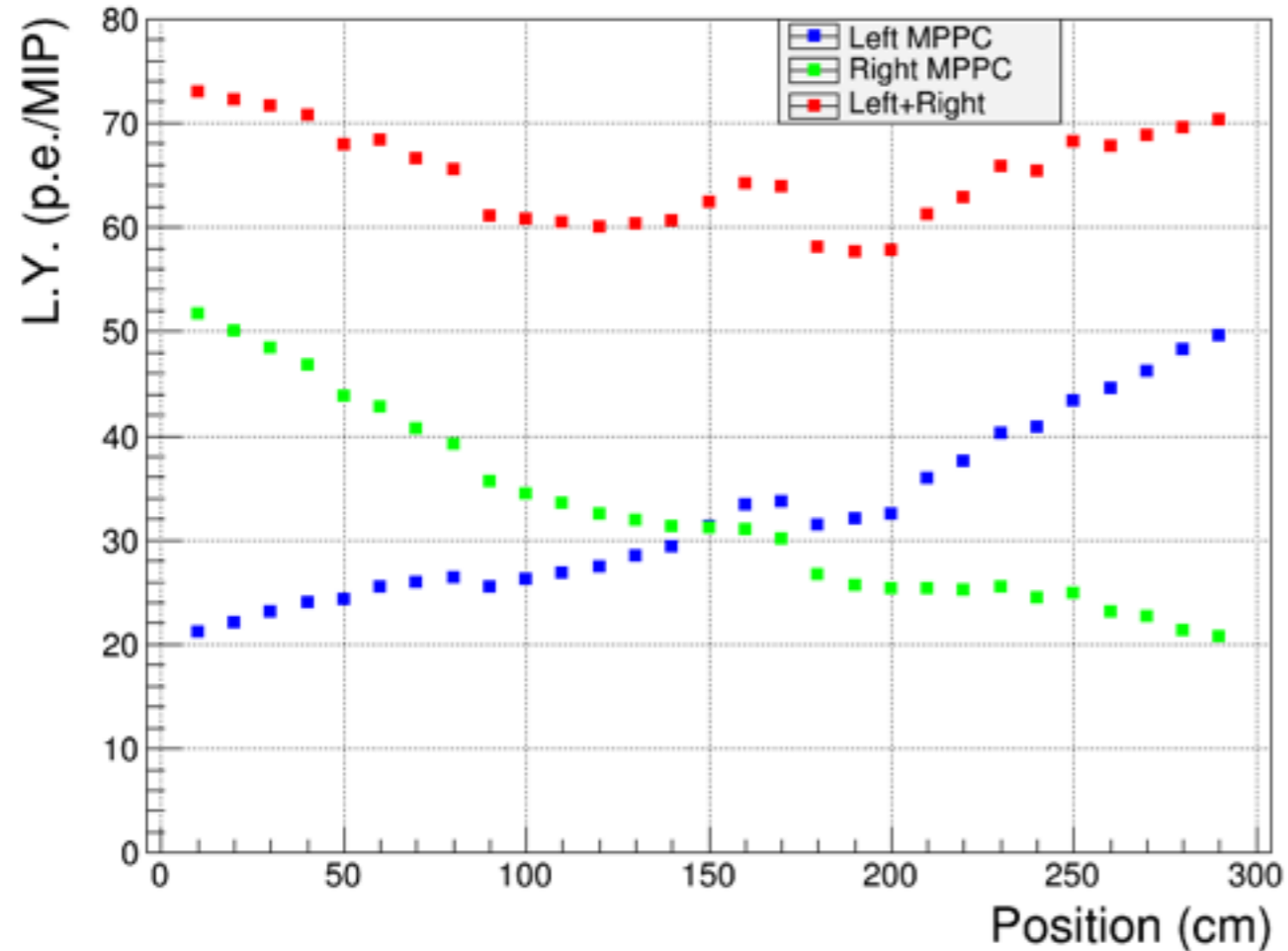

Light yield over length in 3-cm.

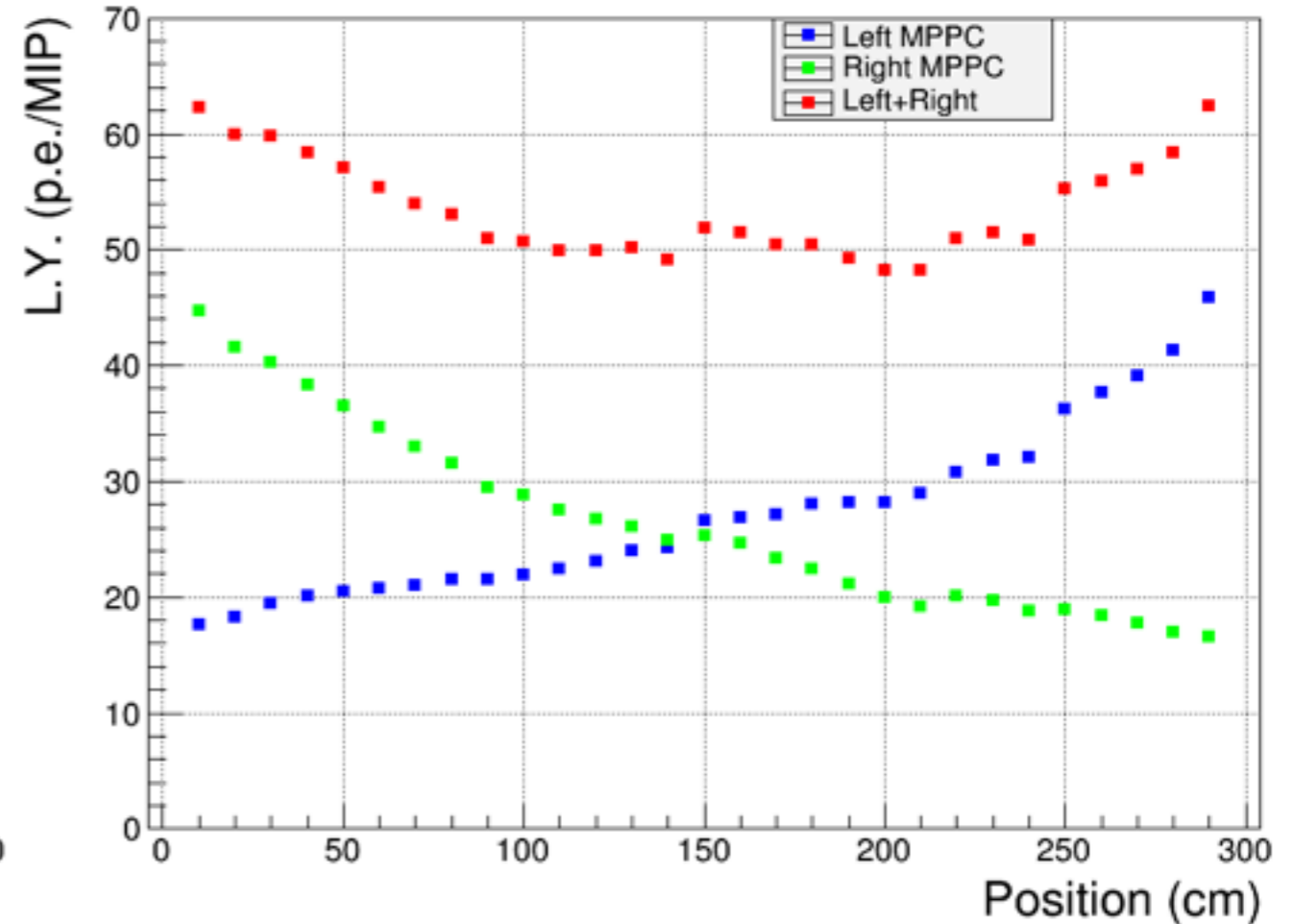

Light yield over length in 5-cm.

Light yield over length in a 10-cm bar with readout by 4 MPPCs or by 2 MPPCs

Two 10-cm bars were irradiated in the beam.

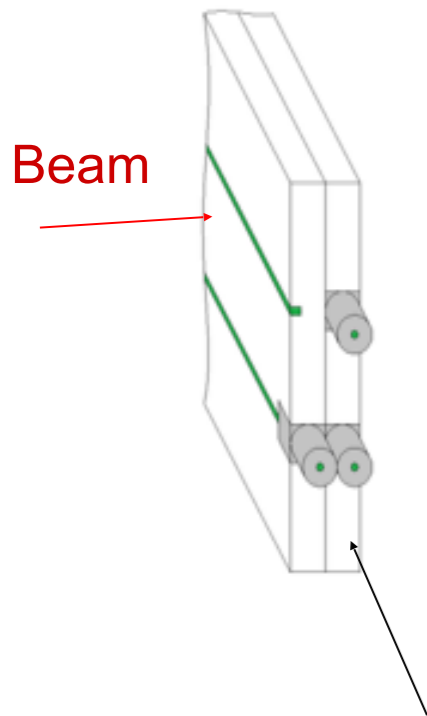

Plot for this bar

One of them is both side read out with 2 fibers, 4 MPPCs. Red points are the sum of all 4 MPPCs.

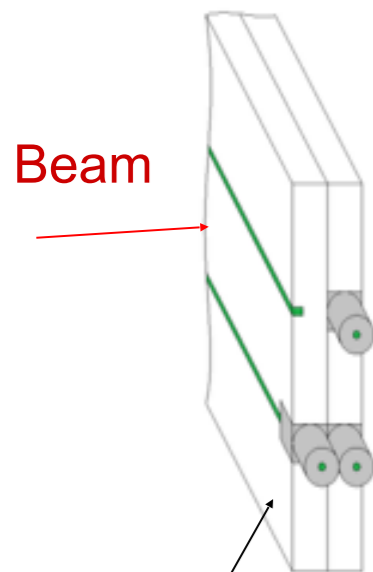
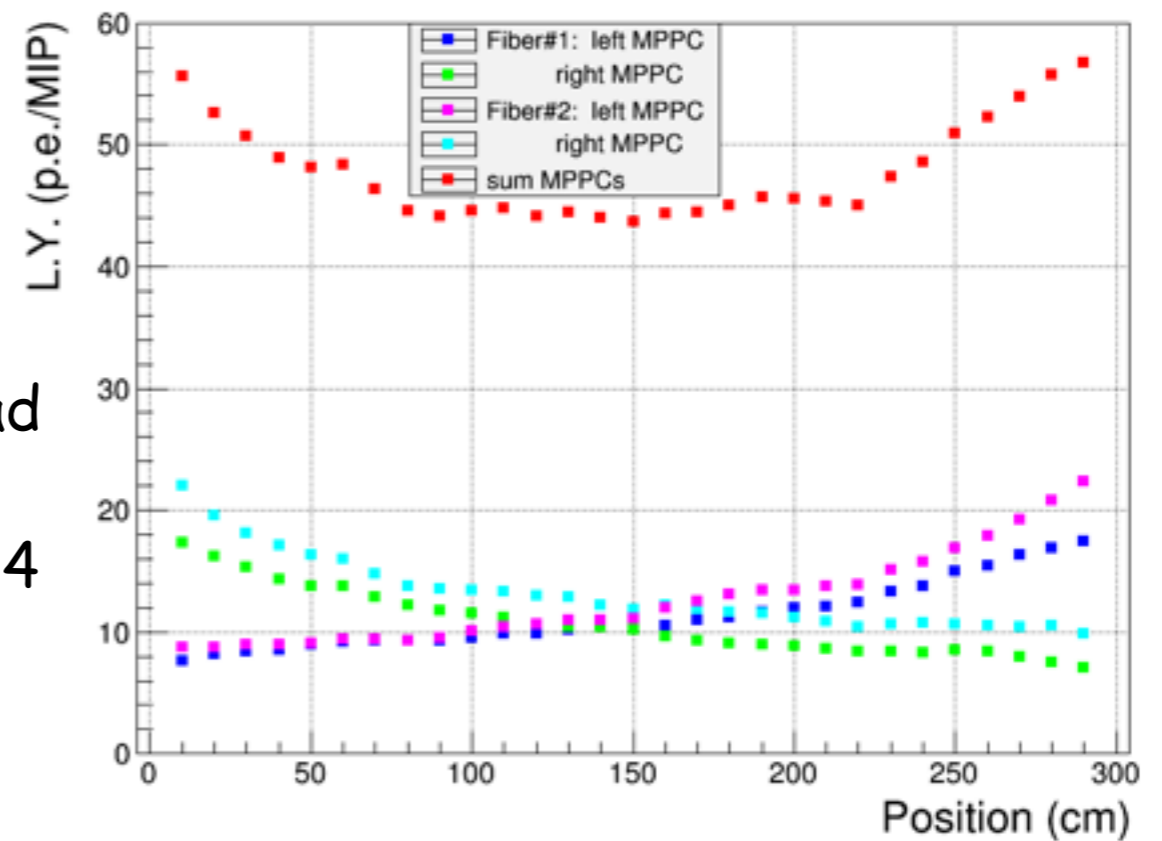

Plot for this bar

One of them is both side read out with 2 fibers, 2 MPPCs. Red points are the sum of both MPPCs.

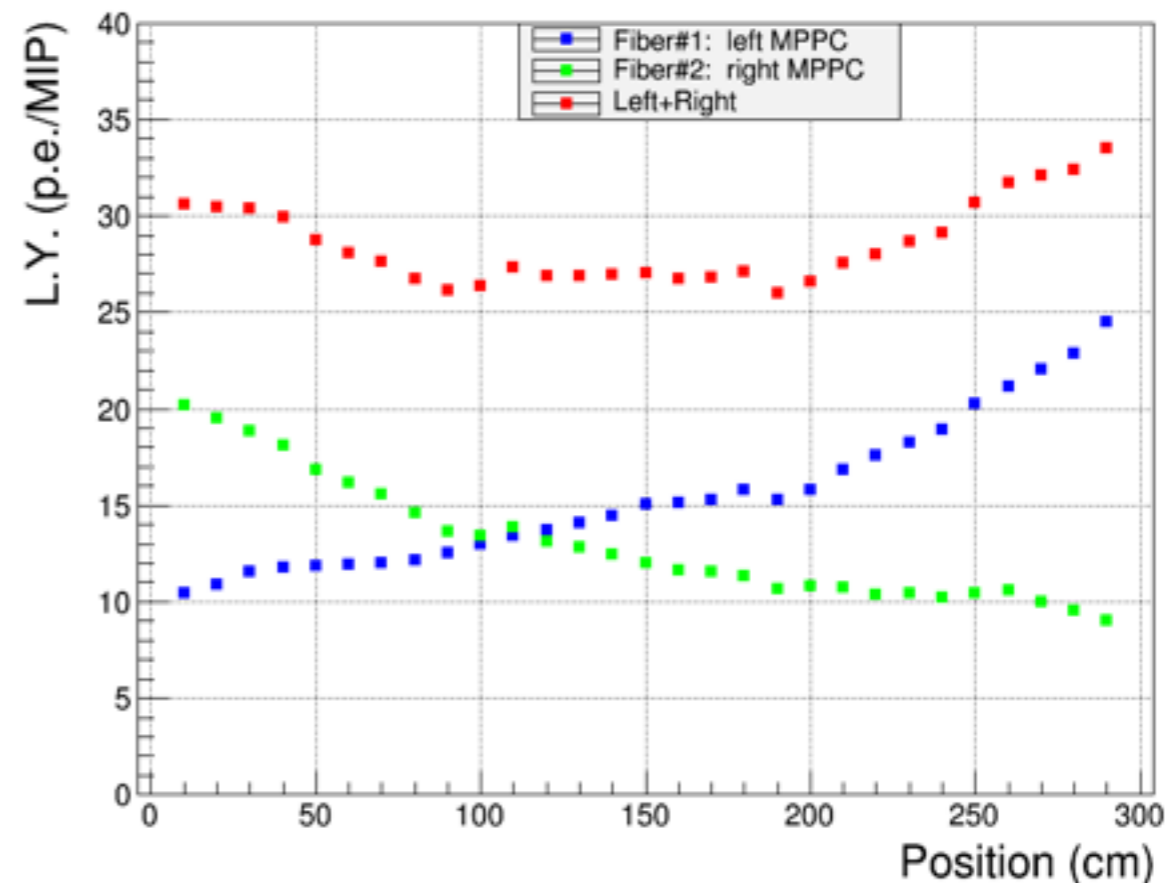

Light yield scan across the bars

3 bars of different size were scanned across the bars. Beam spot of $3 \times 3 \text{ mm}^2$ was defined by a small plastic counter. We have selected only the events where the signal in the small counter was above some threshold.

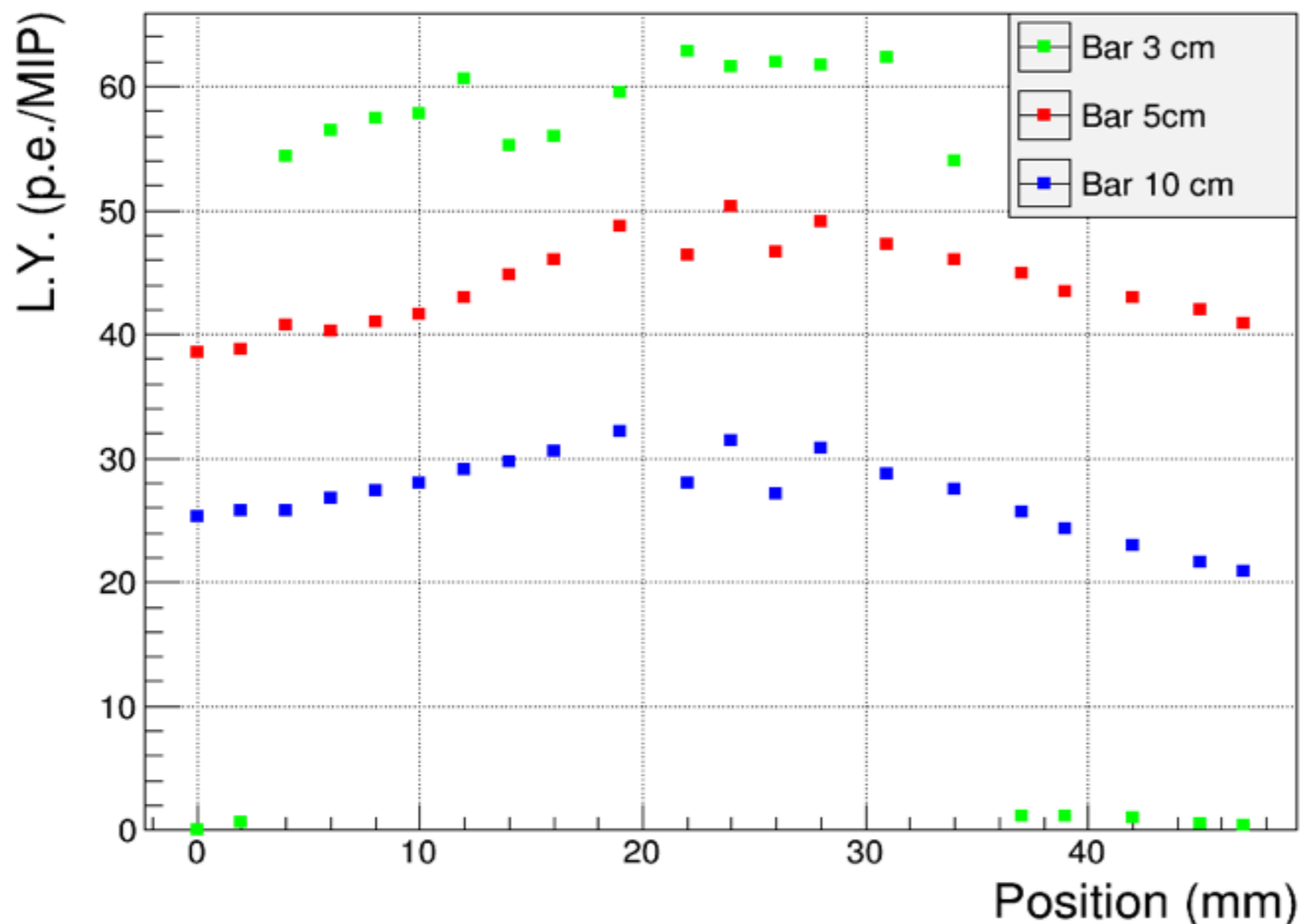

Scan was done in the center between MPPCs. First point (0 cm position) is near the bar edges, and then points over 5 cm towards the opposite edge.

Light yield shown is the sum from both bar ends.

WLS fiber is located roughly at 25 mm position for 5- and 10-cm bars.

For 10 cm bar the readout was implemented with a single fiber.

Light yield scan across a 5-cm bar

Light attenuation in 5-cm bar is almost symmetrical in both directions from the fiber. Attenuation was fitted with exponential function $C \cdot \exp(S \cdot x)$, where x is the position variable, and attenuation length is $1/S$.

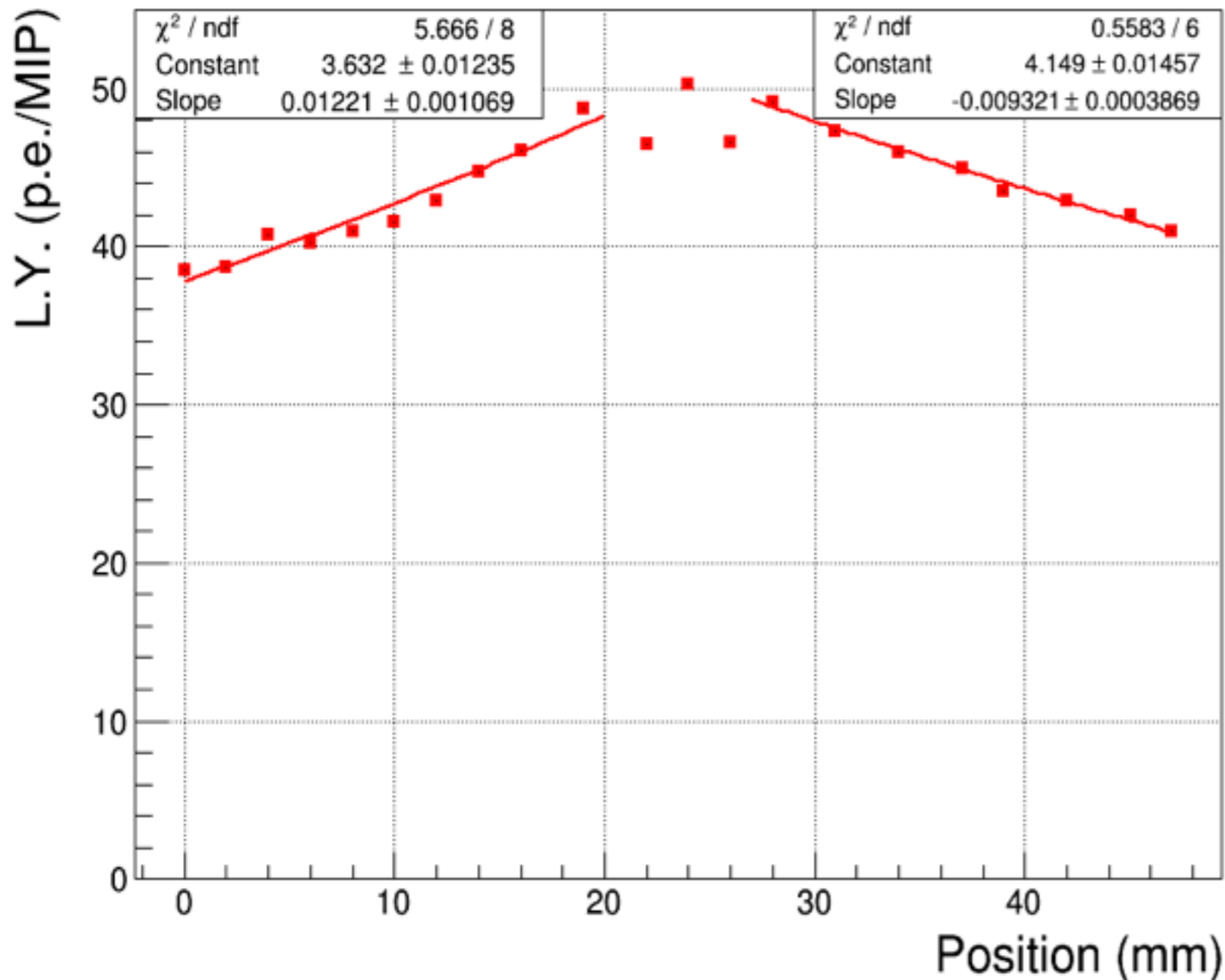

Attenuation length for 5-cm bar was obtained to be 82 and 107 mm, **94 mm in average.**

This parameter specifies the attenuation of scintillating light in 7 mm thick extruded scintillator, where the light reflections from the edges contribute in collection of scintillating light on a WLS fiber.

Light yield scan across a 10-cm bar

Light attenuation in 10-cm bar is asymmetrical because of the effect of reflective edge. Attenuation was fitted with exponential function $C \cdot \exp(S \cdot x)$, where x is the position variable, and attenuation length is $1/S$.

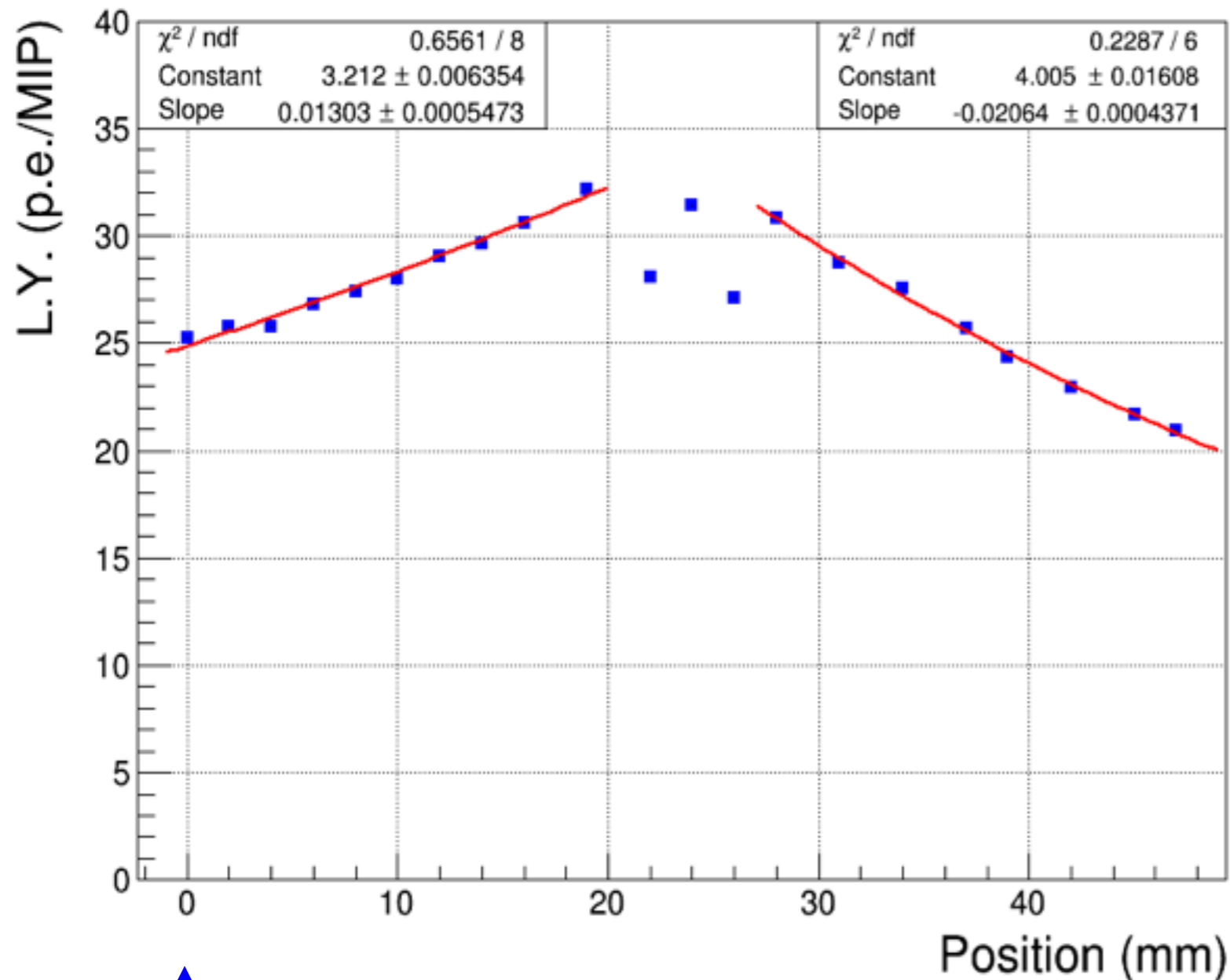

Attenuation length for 10-cm bar was obtained: **77 mm** towards the edge, **48 mm** in the opposite direction.

The **48 mm attenuation length** specifies the attenuation of scintillating light in 7 mm thick extruded scintillator, where the effect of reflections from edges is suppressed.

Calculation of time coordinate

For timing we fit with the straight lines the baseline before a signal pulse and the front of this pulse. **Crossing of the lines gives relative time coordinate of the pulse.**

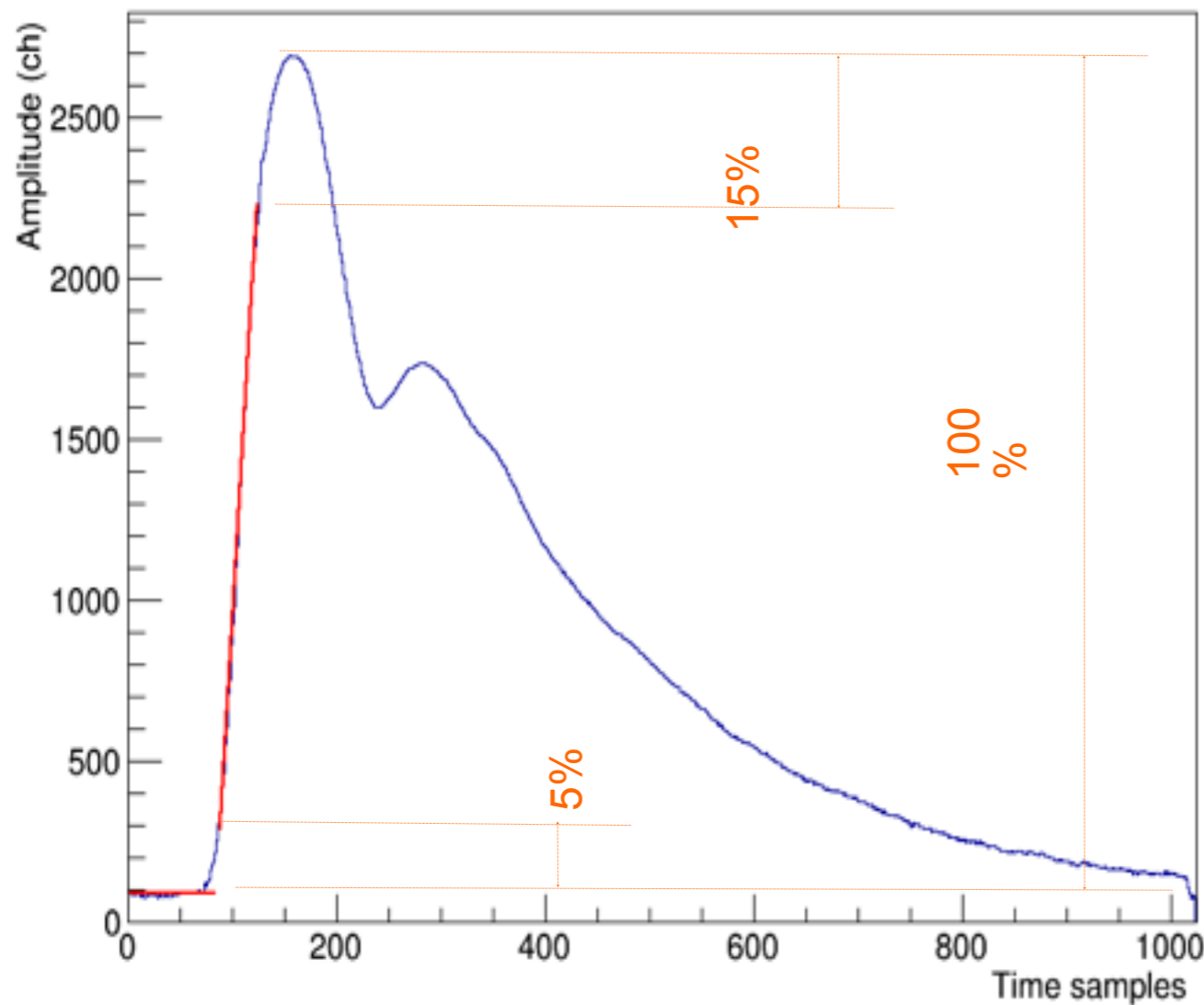

Fit area on pulse front is determined in the following way:

1. Pulse height is taken as 100%.
2. First time stamp is at the level of 5% from the baseline.
3. Last time stamp is at the level of 85% from the baseline.
4. All points between first and last time stamps are fitted with the straight line. Typical number of fitted points are 40-50.

The baseline is fitted with horizontal straight line.

Contribution from trigger in timing

We have checked 3 combinations of times at the bar ends T_1 and T_2 :

$(T_1 - T_2)/2$, $(T_1 + T_2)/2$, $((T_1 - T_{tr}) + (T_2 - T_{tr}))/2$, where T_{tr} is time of trigger signal.

Trigger signal was digitized and analyzed in the same way as the signals from the bar ends. Combination $(T_1 - T_2)/2$ removes the contribution from the trigger.

The combination $(T_1 + T_2)/2$ was rejected out of large time fluctuations as shown in the time spectra for a point in a 3-cm bar:

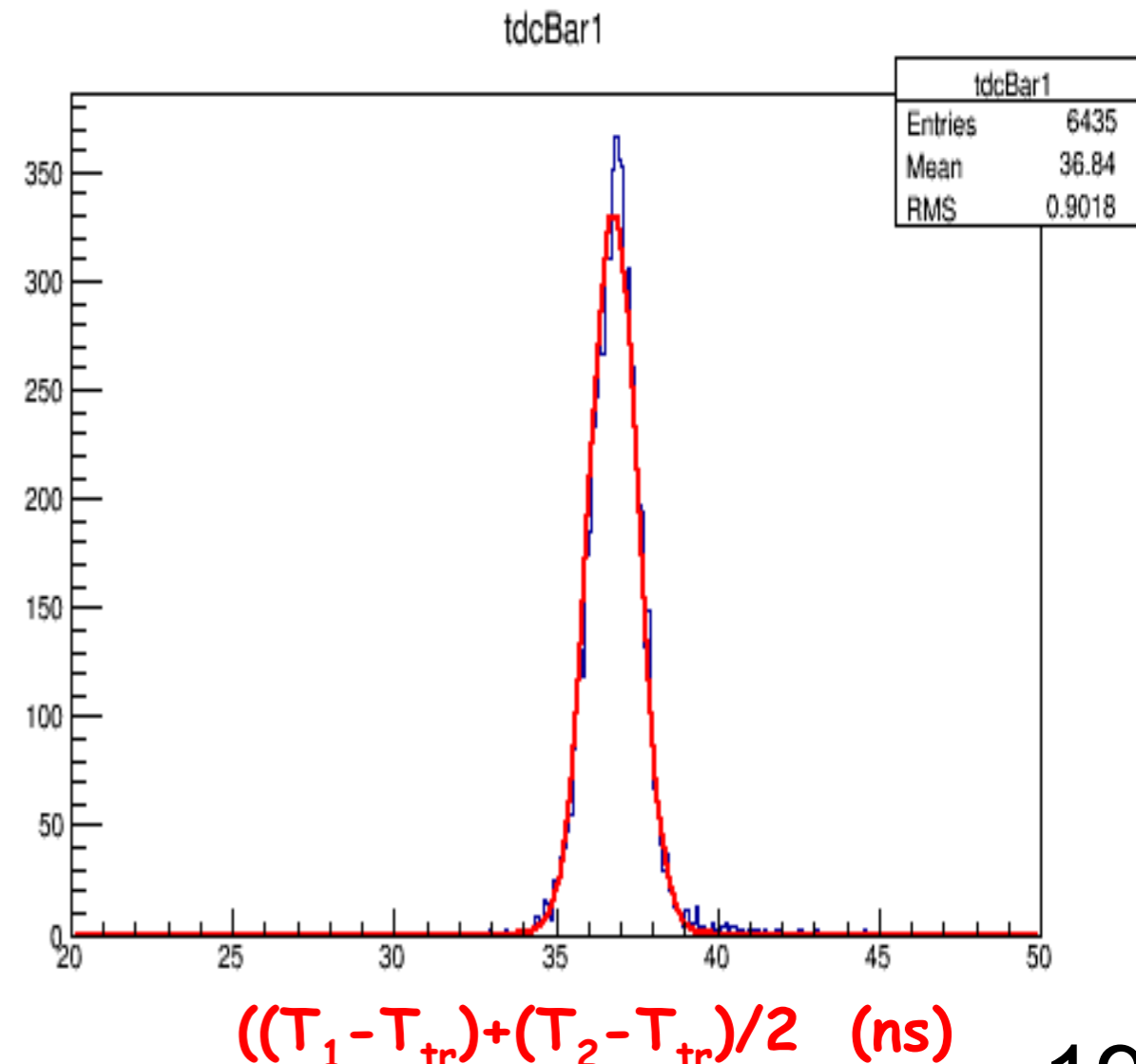
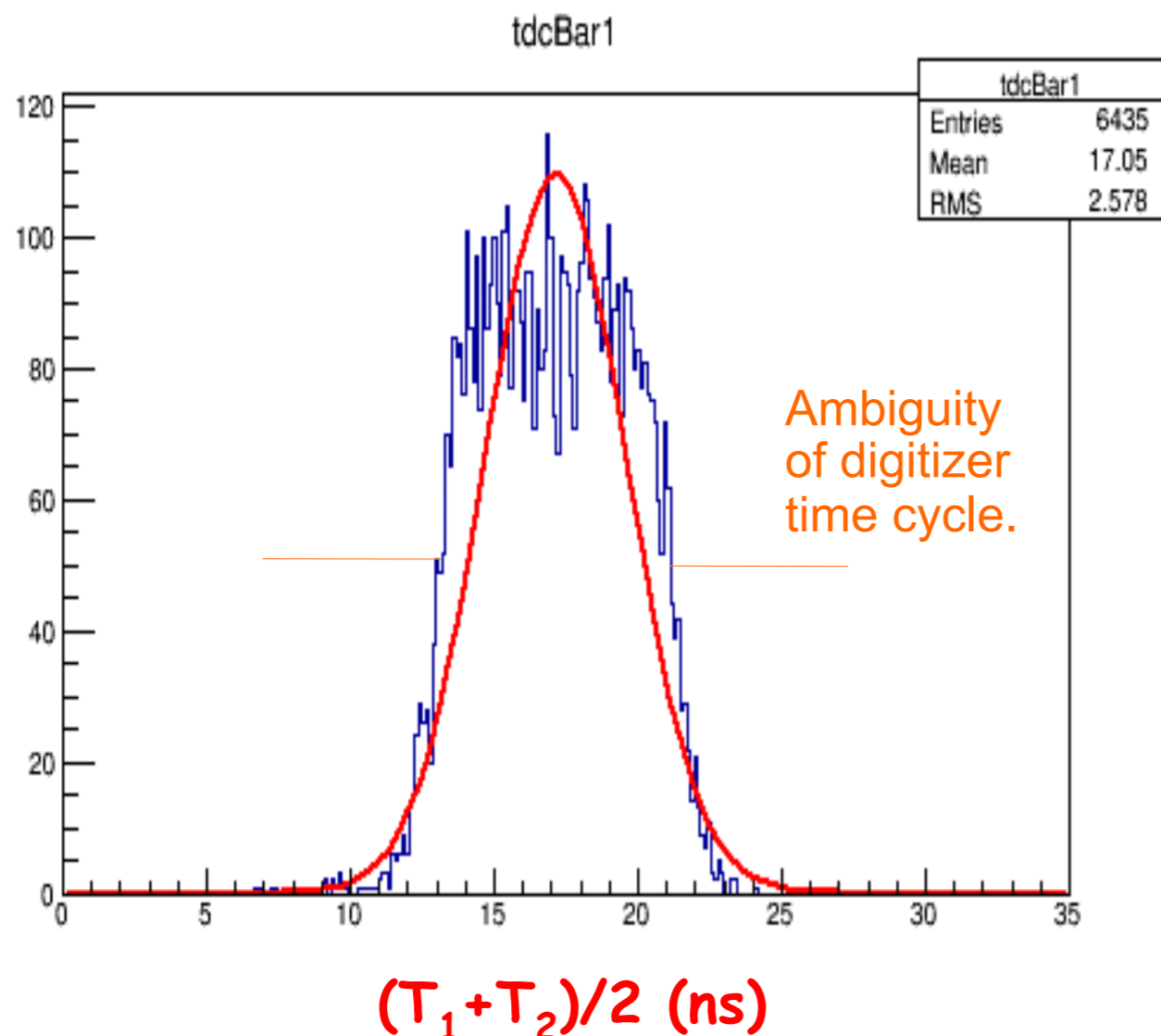

Intrinsic timing for 3- and 5-cm bars vs position along the bars

Time resolution σ_t was calculated for distribution $(T_{\text{left}} - T_{\text{right}})/2$. Contribution from the trigger is excluded in this combination. Each point is the average for 3 bars.

Average $\sigma_t = 694$ ps

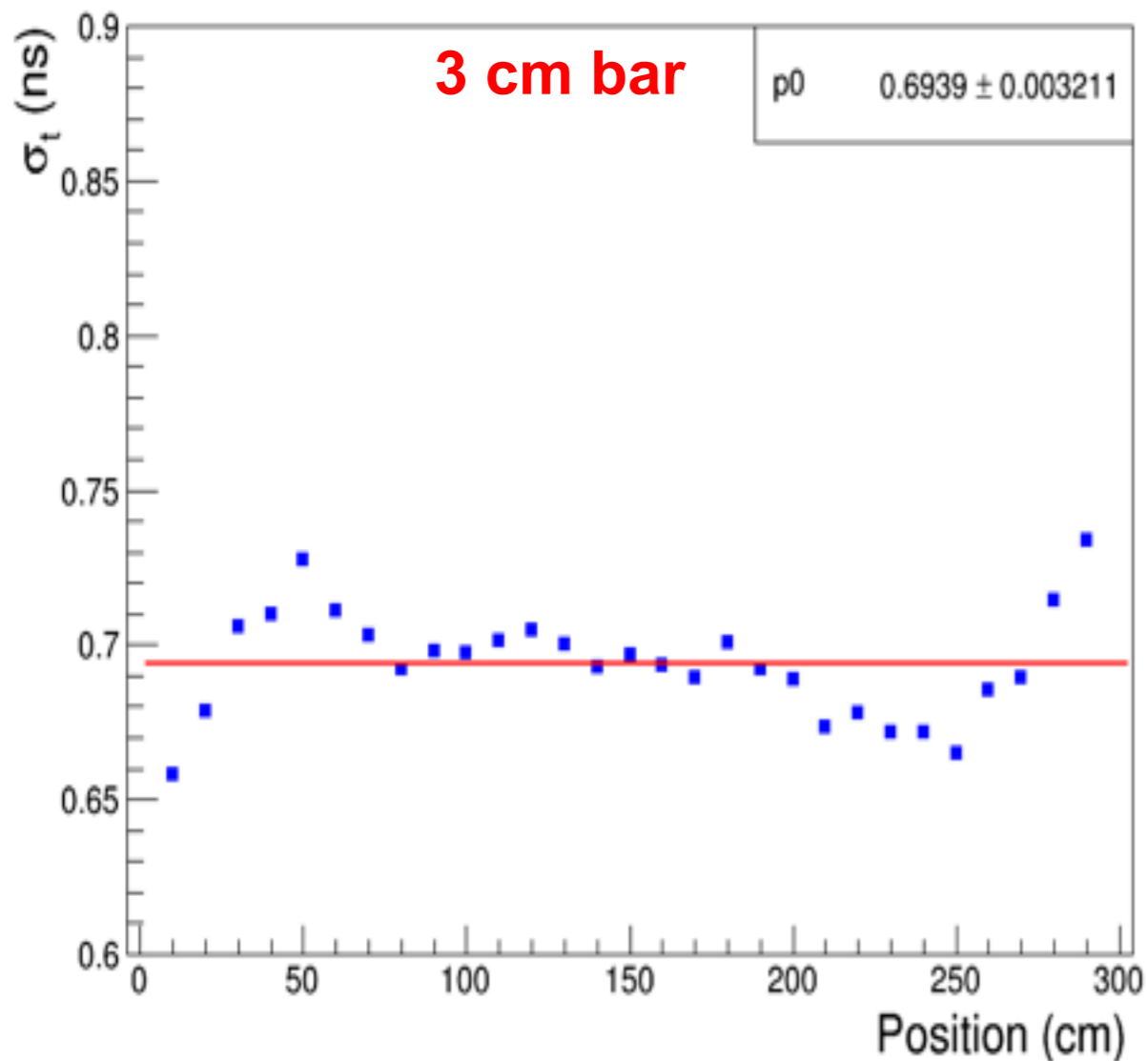

Average $\sigma_t = 785$ ps

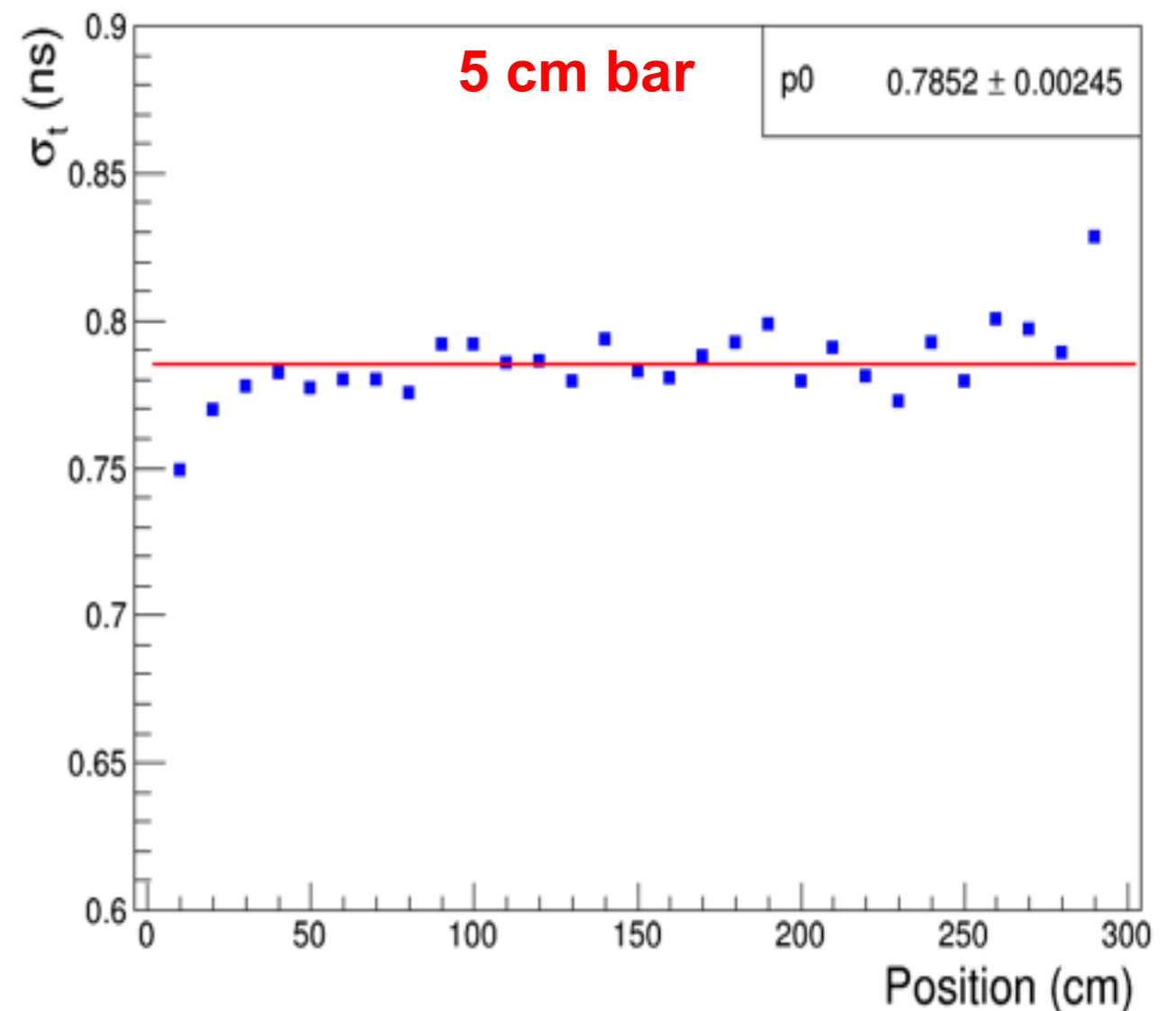

Timing for 3- and 5-cm bars vs position along the bars

Time resolution σ_t was calculated for distribution $(T_{\text{left}} + T_{\text{right}})/2$, where T is the signal time minus trigger time. Trigger jitter contributes in σ_t . Each point is the average for 3 bars.

Average $\sigma_t = 724$ ps

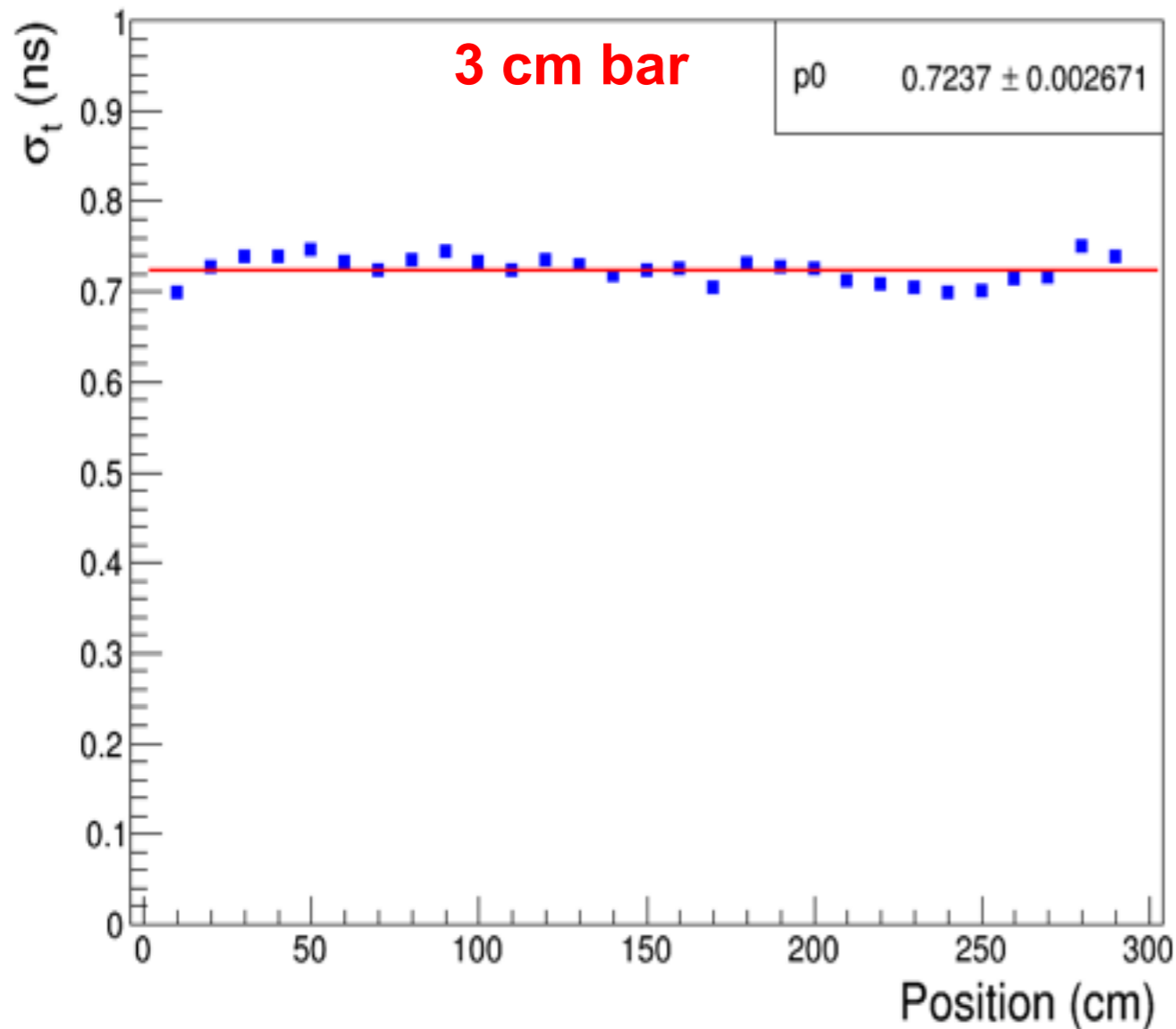

Average $\sigma_t = 819$ ps

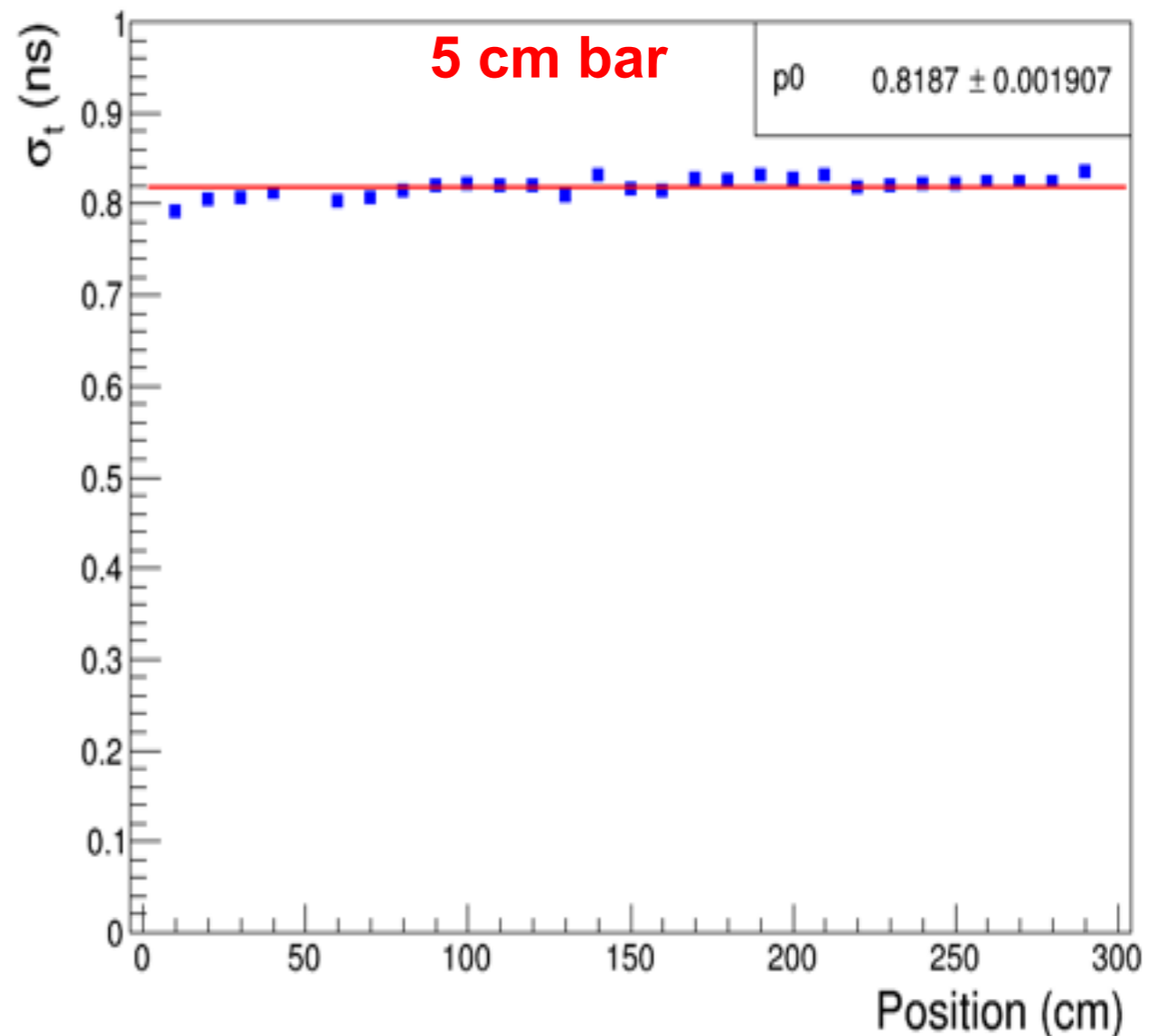

Intrinsic timing for 10-cm bars vs position along the bars

Time resolution σ_t was calculated for the bar with 2 MPPCs for distribution $(T_{\text{left}} - T_{\text{right}})/2$, and for the bar with 4 MPPCs for distribution $((T1_{\text{left}} - T1_{\text{right}})/2 + (T2_{\text{left}} - T2_{\text{right}})/2)/2$

Average $\sigma_t = 1.31$ ns

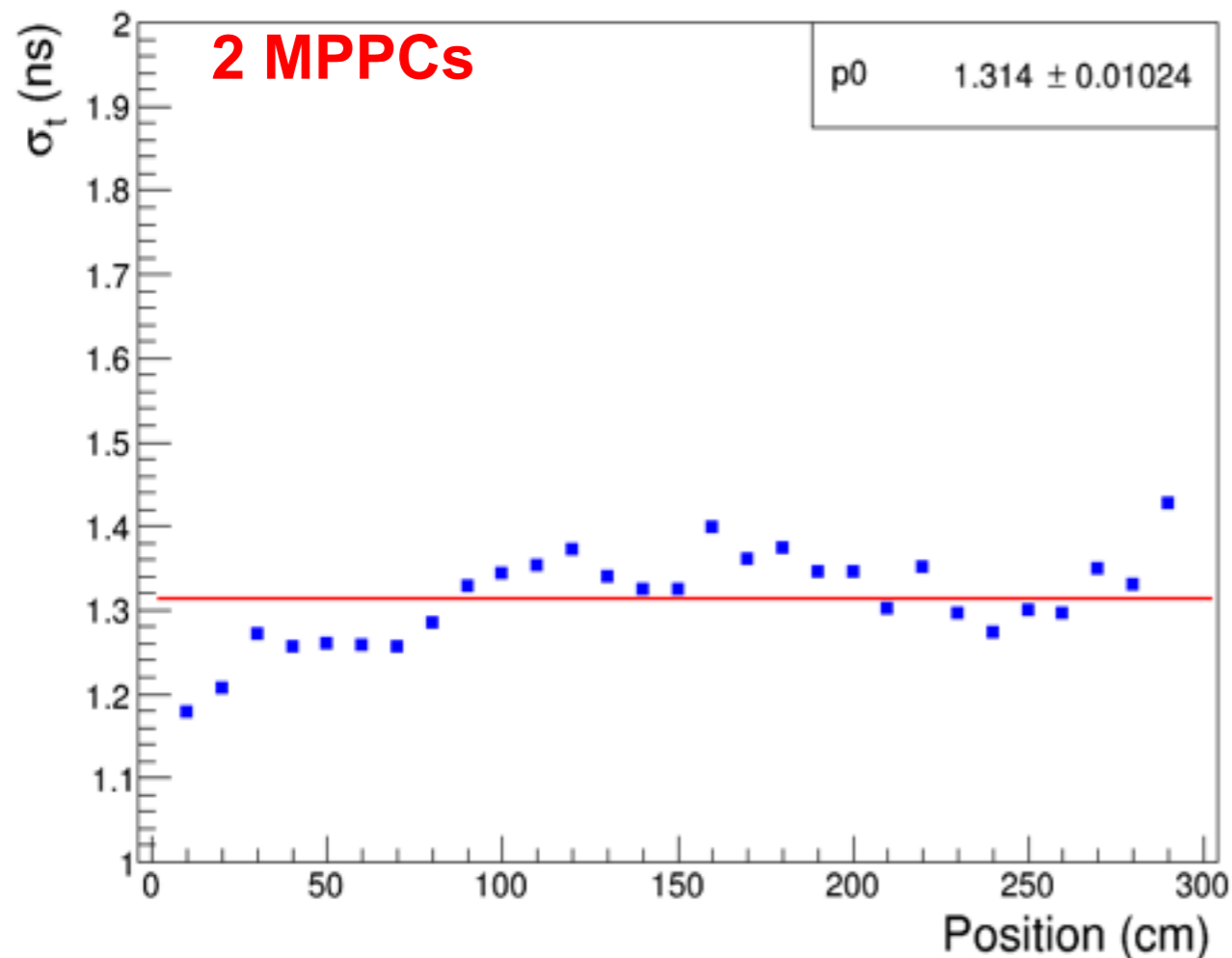

Average $\sigma_t = 0.93$ ns

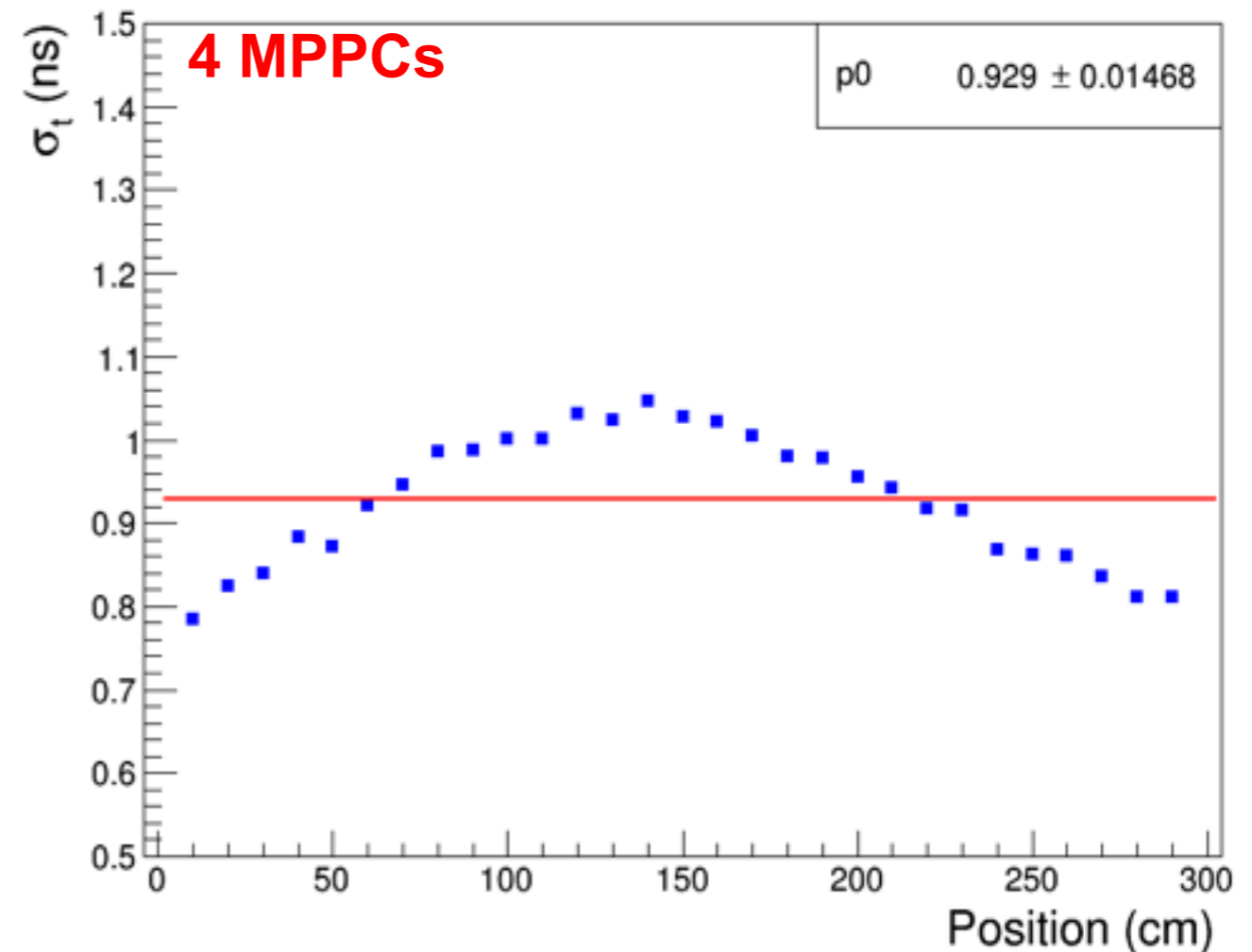

Timing for 10-cm bars vs position along the bars

Time resolution σ_t was calculated for the bar with 2 MPPCs for distribution $(T_{\text{left}} + T_{\text{right}})/2$, and for the bar with 4 MPPCs for distribution $((T1_{\text{left}} + T1_{\text{right}})/2 + (T2_{\text{left}} + T2_{\text{right}})/2)/2$ where T is the signal time minus trigger time. Trigger jitter contributes in σ_t .

Average $\sigma_t = 1.35$ ns

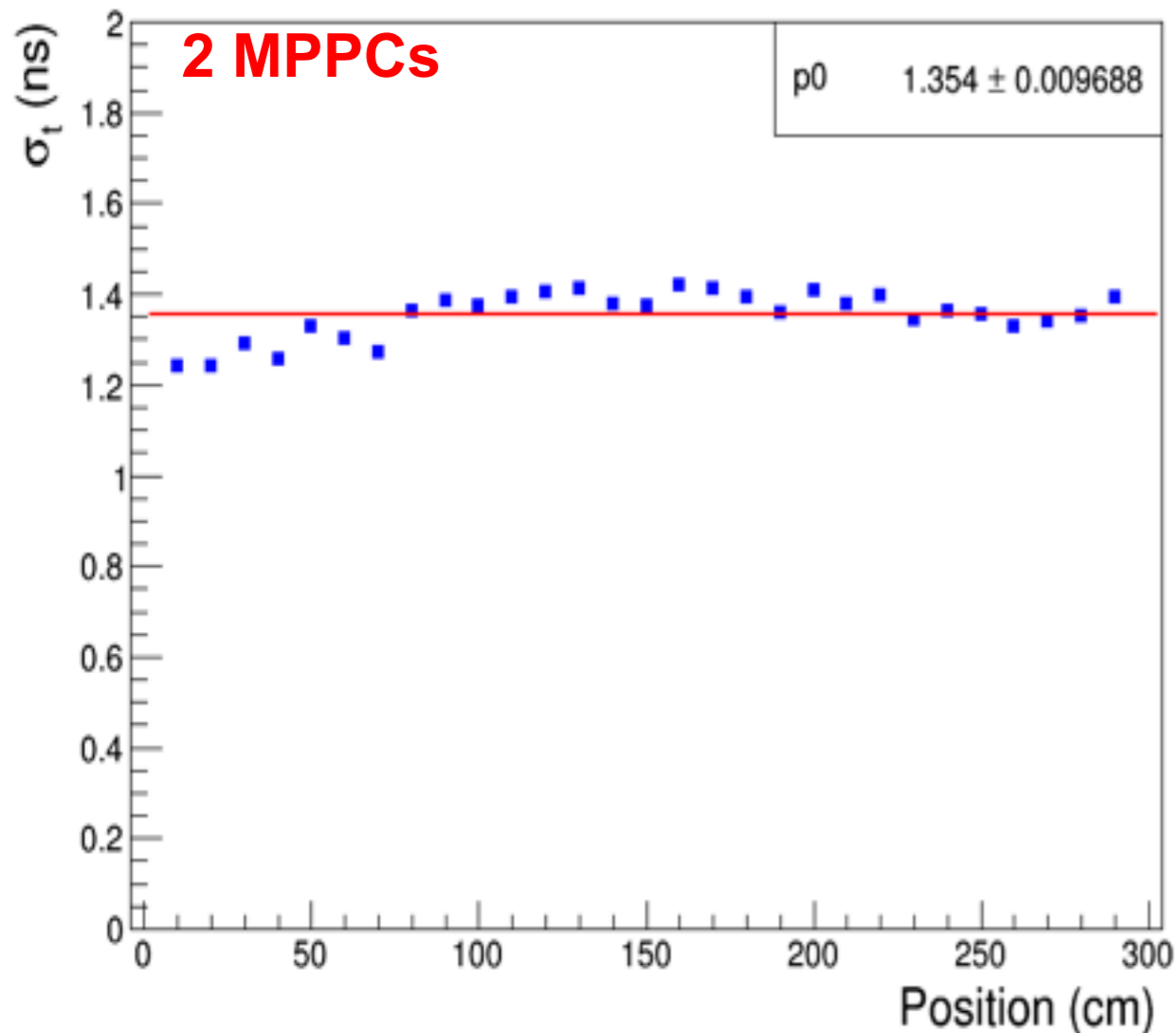

Average $\sigma_t = 0.97$ ns

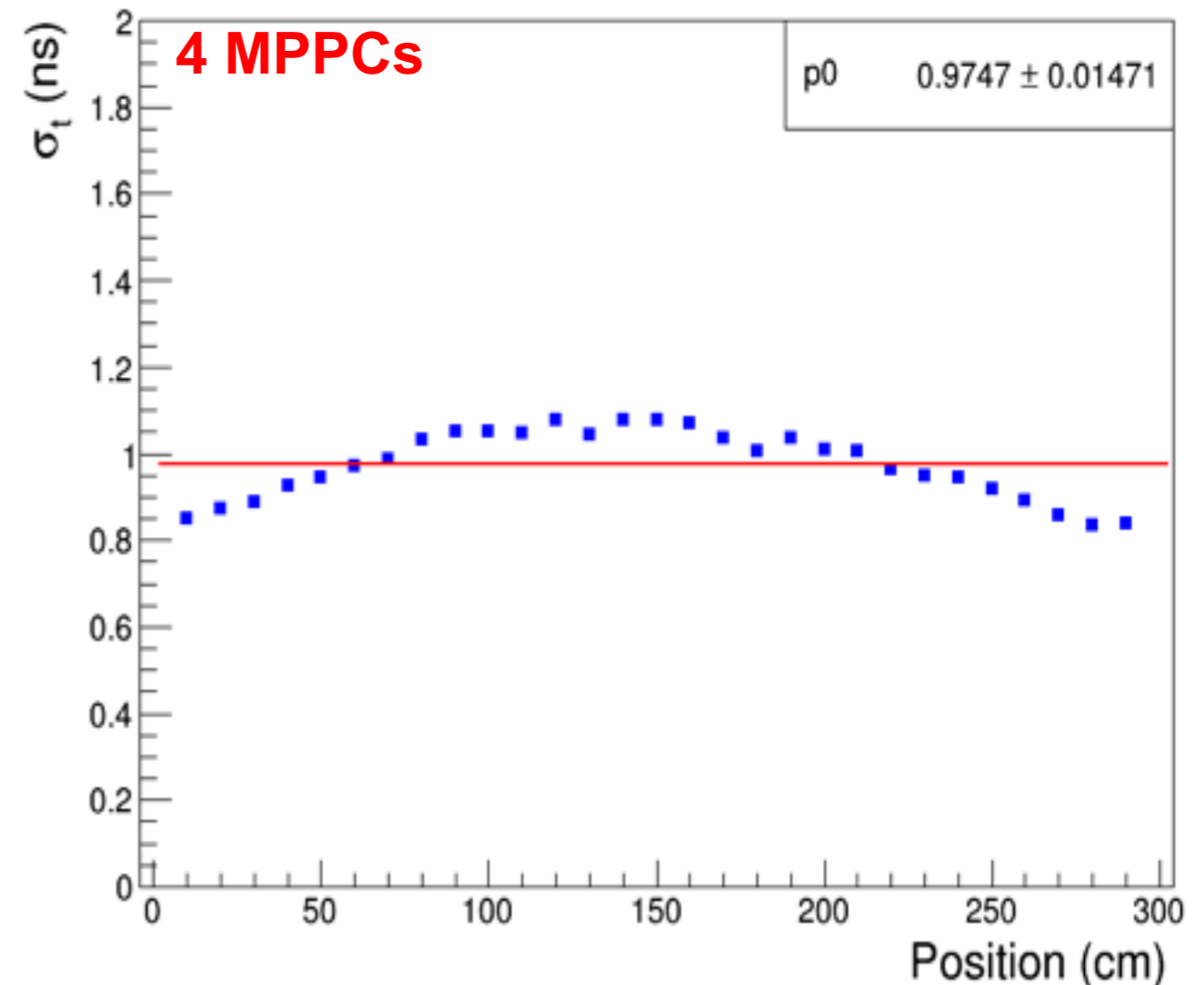

Time resolution at constant fraction method

Time resolution $\sigma_t = (T_{\text{left}} + T_{\text{right}})/2$, where T is the signal time minus trigger time.
Time was measured at fraction 0.15 of the pulse amplitude from pedestal baseline.
Time stamp is counted when the rise front exceeds 15% of the pulse height,
0% corresponds to the fitted level of baseline.

Average $\sigma_t = 707$ ps

Average $\sigma_t = 782$ ps

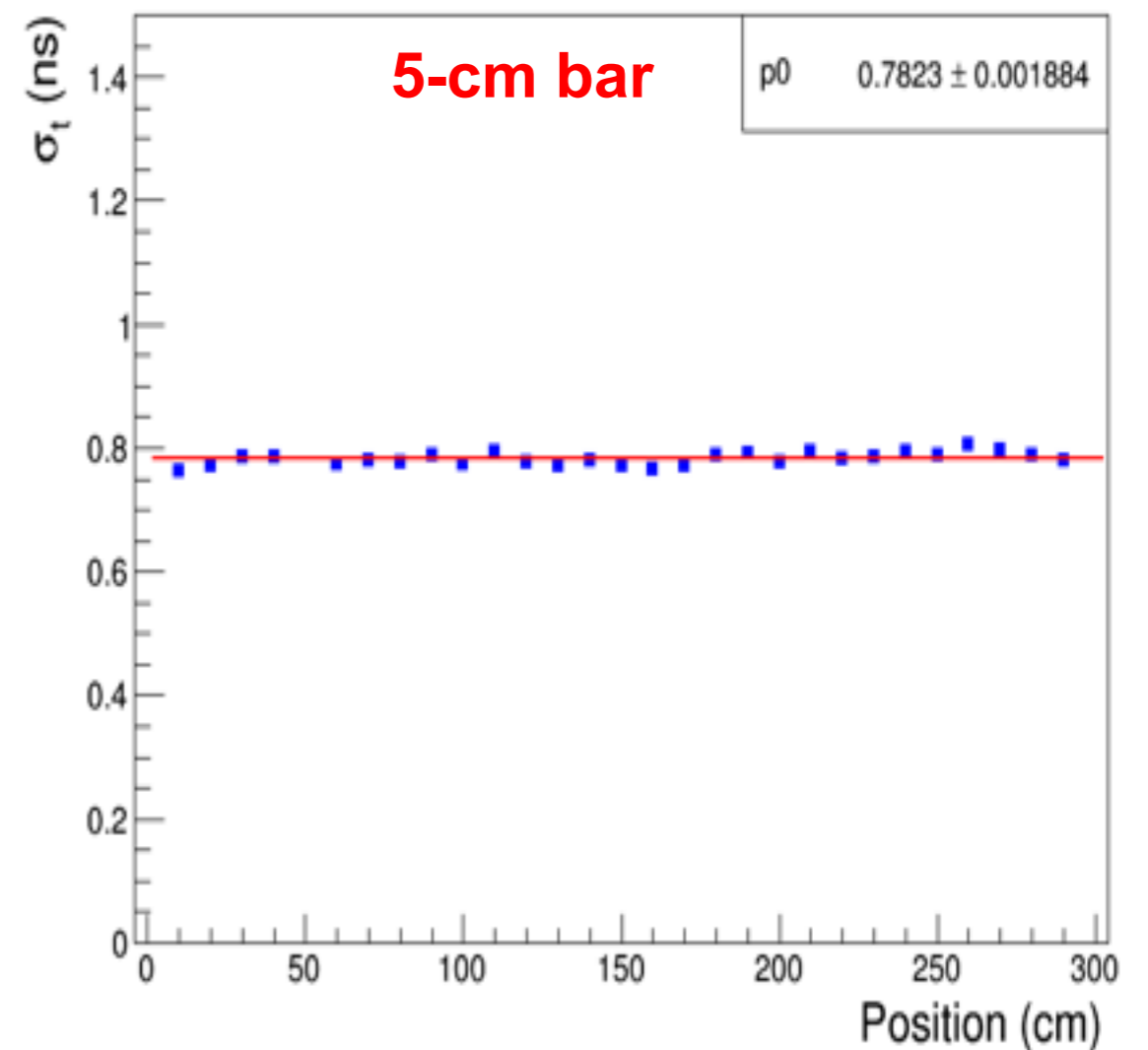
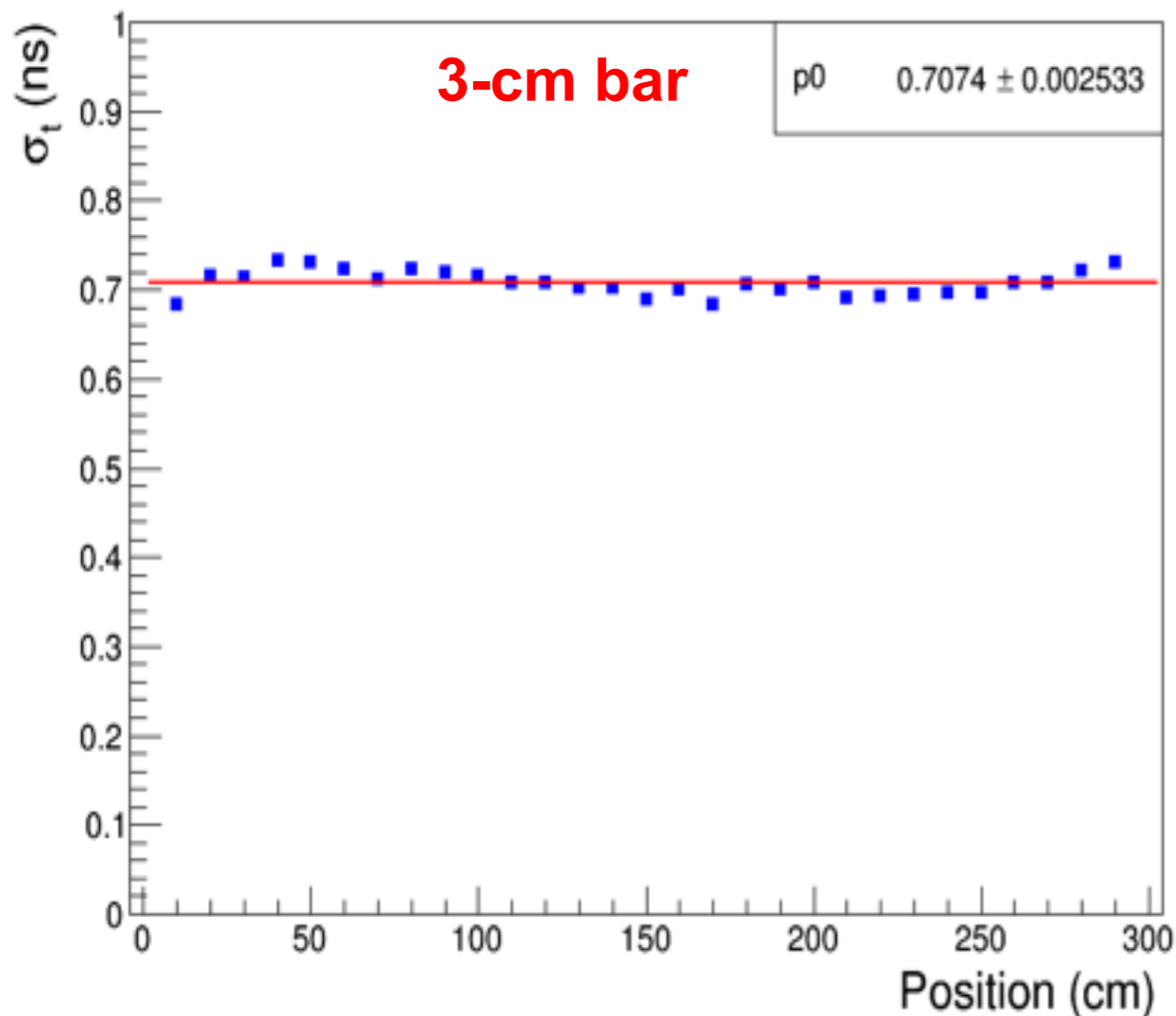

Time resolution vs light yield

Time resolution of a single channel vs light yield was fitted with $p_0 + p_1/\sqrt{\text{L.Y.}}$ in 10 points, for 3-, 5- and 10-cm bars. Two points, one for 3- and another one for 10-cm bars are shown below.

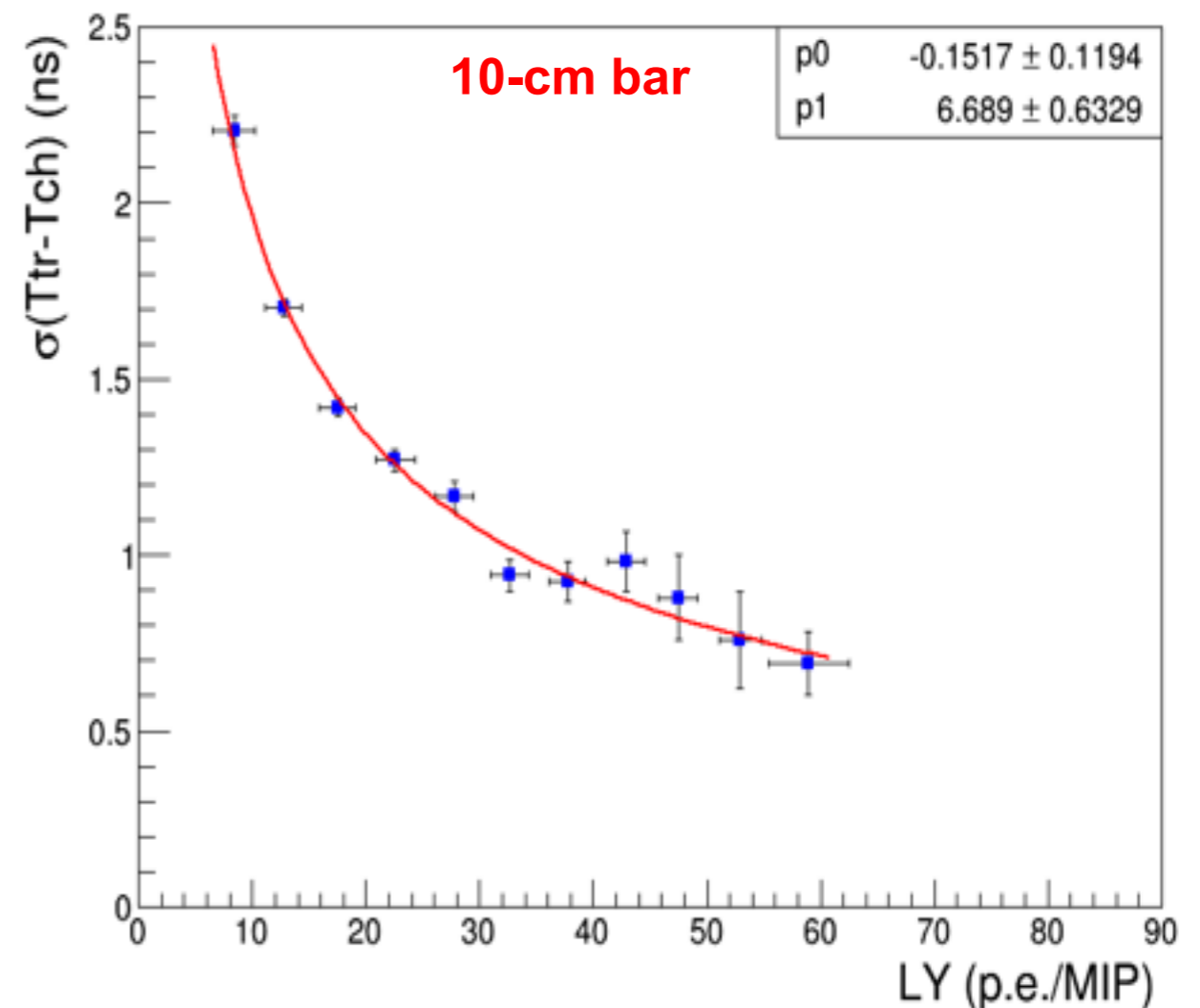
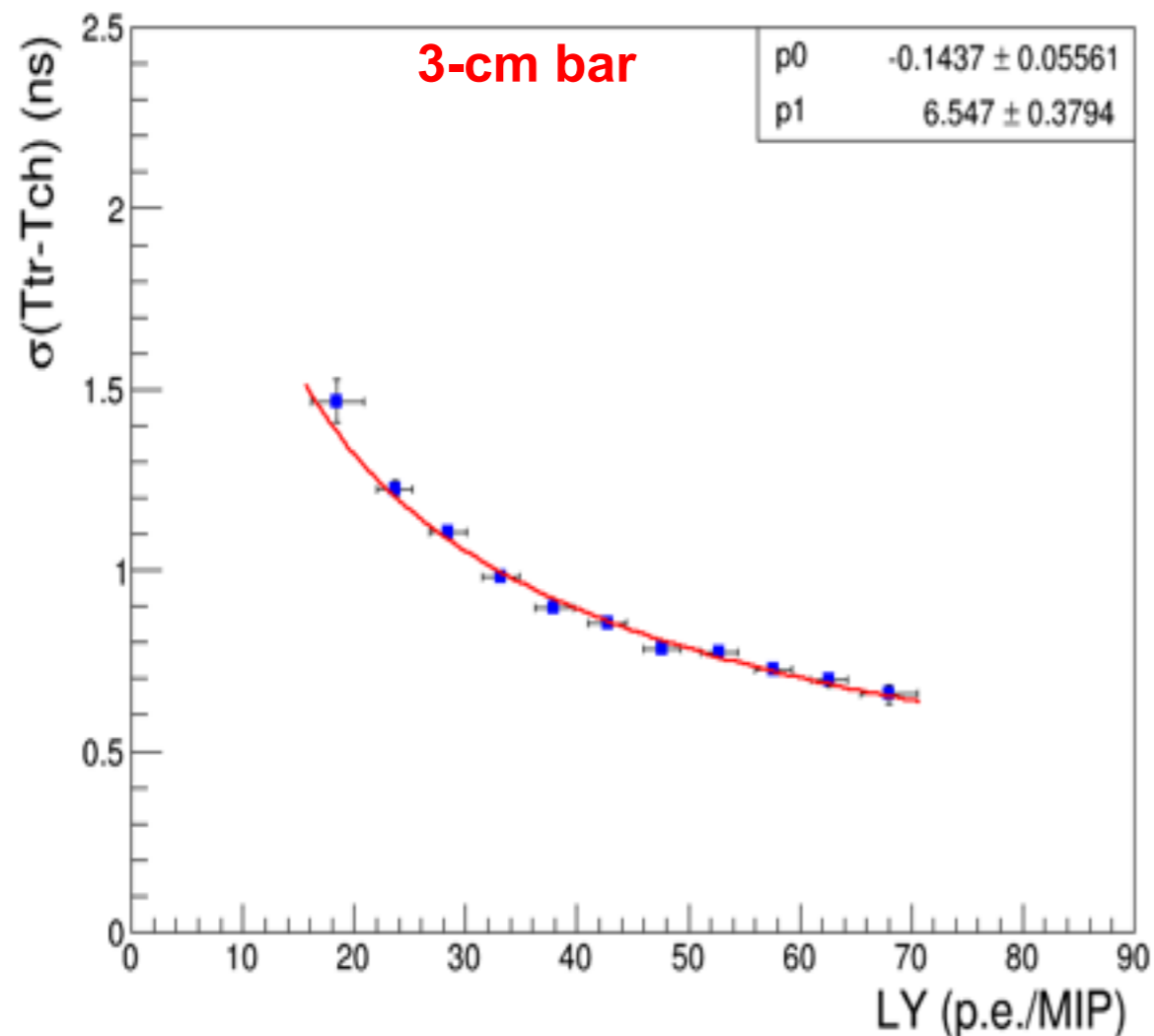

The parameter p_0 is negative that brings no physical sense. The result is explained by low statistics for points with high L.Y. Average parameter p_1 was found to be 6.5 ns.

Summary

4 types of 3 m long extruded scintillator bars were tested in a beam at CERN. Thickness of all bars is 7 mm, covered by chemical reflector.

Bar type	3 cm	5 cm	10 cm, 4 MPPCs	10 cm, 2 MPPCs
Light yield in the center (sum from both ends), p.e./MIP	60	50	45	27
Time resolution σ_t for $(t_1-t_2)/2$, ns	0.69	0.79	0.93	1.31
Time resolution σ_t for $(t_1+t_2)/2$, ns	0.72	0.82	0.97	1.35

Trigger jitter σ_t is estimated to be around 210 ps .

Conclusions

1. Smaller bars produce higher light yield and better time resolution. However the difference between 3- and 5-cm bars is not significant and can be minimized by quality of scintillator or performance of photosensors.
2. One 10-cm bar with 4 MPPCs is close in cost per channel to two 5-cm bars. But two 5-cm bars provide better performance in position resolution, first of all, light yield and timing.
3. Constant fraction discrimination at level of 0.15 seems to provide better timing than fitting of the pulse front.

